

ETSI EN 301 357-1 V1.3.1 (2006-07)

European Standard (Telecommunications series)

Electromagnetic compatibility and Radio spectrum Matters (ERM); Cordless audio devices in the range 25 MHz to 2 000 MHz; Part 1: Technical characteristics and test methods



Reference

REN/ERM-TG17WG3-007-1

Keywords

audio, radio, radio MIC, testing

ETSI

650 Route des Lucioles
F-06921 Sophia Antipolis Cedex - FRANCE

Tel.: +33 4 92 94 42 00 Fax: +33 4 93 65 47 16

Siret N° 348 623 562 00017 - NAF 742 C
Association à but non lucratif enregistrée à la
Sous-Préfecture de Grasse (06) N° 7803/88

Important notice

Individual copies of the present document can be downloaded from:

<http://www.etsi.org>

The present document may be made available in more than one electronic version or in print. In any case of existing or perceived difference in contents between such versions, the reference version is the Portable Document Format (PDF). In case of dispute, the reference shall be the printing on ETSI printers of the PDF version kept on a specific network drive within ETSI Secretariat.

Users of the present document should be aware that the document may be subject to revision or change of status. Information on the current status of this and other ETSI documents is available at

<http://portal.etsi.org/tb/status/status.asp>

If you find errors in the present document, please send your comment to one of the following services:

http://portal.etsi.org/chaicor/ETSI_support.asp

Copyright Notification

No part may be reproduced except as authorized by written permission.
The copyright and the foregoing restriction extend to reproduction in all media.

© European Telecommunications Standards Institute 2006.
All rights reserved.

DECT™, **PLUGTESTS™** and **UMTS™** are Trade Marks of ETSI registered for the benefit of its Members.
TIPHON™ and the **TIPHON logo** are Trade Marks currently being registered by ETSI for the benefit of its Members.
3GPP™ is a Trade Mark of ETSI registered for the benefit of its Members and of the 3GPP Organizational Partners.

Contents

Intellectual Property Rights	7
Foreword.....	7
Introduction	8
1 Scope	9
2 References	10
3 Definitions, symbols and abbreviations	11
3.1 Definitions	11
3.2 Symbols.....	11
3.3 Abbreviations	12
4 Functional characteristics	12
4.1 Cordless audio	12
4.1.1 In-vehicle cordless	12
4.1.2 Personal cordless	12
4.1.3 Broadband multi channel systems	12
4.1.4 Band II LPD.....	13
4.2 Consumer radio microphones.....	13
4.3 In-ear monitoring.....	13
5 General	13
5.1 Presentation of equipment for testing purposes.....	13
5.1.1 Choice of model for performance testing	14
5.1.2 Definitions of alignment and switching ranges.....	14
5.1.3 Alignment Range	14
5.1.4 Choice of frequencies	14
5.1.5 Testing of single channel equipment	14
5.1.6 Testing of two channel equipment.....	14
5.1.7 Testing of multi-channel equipment (more than two channels).....	14
5.1.8 Testing of equipment with an external frequency control.....	15
5.1.9 Testing of equipment with an integral antenna	15
5.1.9.1 Equipment with a permanent internal RF port	15
5.1.9.2 Equipment with a temporary RF port.....	15
5.2 Mechanical and electrical design.....	15
5.2.1 General.....	15
5.2.2 Controls	15
5.2.3 Integral antenna	15
5.2.4 Marking	16
5.3 Interpretation of the measurement results	16
6 Test conditions, power sources and ambient conditions	16
6.1 Normal and extreme test-conditions	16
6.2 Test power source.....	16
6.3 Normal test conditions.....	16
6.3.1 Normal temperature and humidity	17
6.3.2 Normal test power source voltage.....	17
6.3.2.1 Mains voltage	17
6.3.2.2 Nickel-cadmium cells.....	17
6.3.2.3 Other power sources.....	17
6.4 Extreme test conditions	17
6.4.1 Extreme temperatures	17
6.4.1.1 Procedures for tests at extreme temperatures	17
6.4.2 Extreme test power source voltages.....	18
6.4.2.1 Mains voltage.....	18
6.4.2.2 Re-chargeable battery power sources.....	18
6.4.2.3 Power sources using other types of batteries.....	18

6.4.2.4	Other power sources.....	18
7	General conditions.....	18
7.1	Normal test modulation.....	18
7.2	Test fixture	19
7.3	Test site and general arrangements for radiated measurements.....	20
7.4	Modes of operation of the transmitter	20
7.5	Arrangement for test signals at the input of the transmitter	20
8	Methods of measurement and limits for transmitter parameters	20
8.1	Basic requirements for Band II LPD	20
8.2	Methods of measurement and limits for transmitter parameters of Band II LPD.....	21
8.2.1	Effective radiated power, occupied bandwidth, channel spacing, frequency error, and transmitter timeout	21
8.2.1.1	Definitions.....	21
8.2.1.2	Test equipment setup.....	21
8.2.1.3	Method of measurement.....	22
8.2.1.3.1	Test site and general arrangements for radiated measurements.....	22
8.2.1.3.2	Test modulation	22
8.2.1.3.3	Measurement procedure	22
8.2.1.4	Limits	22
8.2.1.5	Measurement uncertainty	23
8.2.1.6	Radiated spurious emissions	23
8.2.1.6.1	Definitions	23
8.2.1.6.2	Measurement procedure	23
8.2.1.6.3	Limits for Band II LPD	23
8.2.1.6.4	Limits for combined equipments	23
8.2.1.6.5	Measurement uncertainty	23
8.3	Frequency error	24
8.3.1	Definition	24
8.3.2	Method of measurement	24
8.3.3	Limit	24
8.4	Carrier power.....	24
8.4.1	Definition.....	24
8.4.2	Method of measurement for equipment with integral antenna.....	24
8.4.2.1	Method of measurement under normal test conditions	24
8.4.2.2	Method of measurement under extreme test conditions	25
8.4.3	Limit	25
8.5	Channel bandwidth.....	26
8.5.1	Definition.....	26
8.5.2	Measurement of Necessary Bandwidth (BN)	26
8.5.3	Limits.....	26
8.5.4	Edge of Band Limits	26
8.6	Spurious emissions and cabinet radiation.....	27
8.6.1	Definitions	28
8.6.2	Method of measuring the effective radiated power.....	28
8.6.3	Limits.....	28
8.6.4	Measuring receiver	28
8.7	Cordless audio transmitter shutoff.....	29
8.7.1	Definition.....	29
8.7.2	Method of measurement	29
8.7.3	Limits.....	29
9	Receiver.....	30
9.1	Spurious emissions and cabinet radiation.....	30
9.1.1	Definitions	30
9.1.2	Method of measuring the power level in a specified load.....	30
9.1.3	Method of measuring the effective radiated power of the enclosure	30
9.1.4	Method of measuring the effective radiated power.....	31
9.1.5	Limits.....	31
10	Measurement uncertainty	31

10.1	Compliance assessment when measurement uncertainty is equal to or less than maximum acceptable uncertainty	31
10.2	Compliance assessment when measurement uncertainty is greater than maximum acceptable uncertainty	32
10.3	Maximum allowable measurement uncertainties	32
Annex A (normative): Radiated measurement.....		33
A.1	Test sites and general arrangements for measurements involving the use of radiated fields	33
A.1.1	Anechoic chamber	33
A.1.2	Anechoic chamber with a conductive ground plane	34
A.1.3	Open Area Test Site (OATS)	35
A.1.4	Test antenna	36
A.1.5	Substitution antenna	37
A.1.6	Measuring antenna	37
A.1.7	Stripline arrangement	37
A.1.7.1	General.....	37
A.1.7.2	Description.....	37
A.1.7.3	Calibration	37
A.1.7.4	Mode of use	37
A.2	Guidance on the use of radiation test sites	38
A.2.1	Verification of the test site	38
A.2.2	Preparation of the EUT.....	38
A.2.3	Power supplies to the EUT	38
A.2.4	Volume control setting for analogue speech tests	38
A.2.5	Range length.....	39
A.2.6	Site preparation	39
A.3	Coupling of signals.....	40
A.3.1	General	40
A.3.2	Data Signals.....	40
A.3.3	Speech and analogue signals	40
A.3.3.1	Acoustic coupler description.....	40
A.3.3.2	Calibration	41
A.4	Standard test position	41
A.5	Test fixture	41
A.5.1	Description	41
A.5.2	Calibration.....	42
A.5.3	Mode of use.....	43
Annex B (normative): Measurement of Necessary Bandwidth (BN)		44
Annex C (informative): Receiver parameters.....		45
C.1	Blocking or desensitization	45
C.1.1	Definition	45
C.1.2	Method of measurement.....	45
C.1.2.1	Measurement procedure.....	45
C.1.2.2	Definitions	45
C.1.2.3	Limits for applications below 1 GHz.....	46
C.1.2.4	Limits for applications above 1 GHz	46
C.2	Frequency mask for the receiver part	46
C.2.1	Definition	46
C.2.2	Method of measurement	46
C.2.3	Typical values for receivers.....	47
C.2.3.1	Typical values for receivers with analogue modulation.....	47
C.2.3.2	Typical values for receivers with digital modulation.....	47
Annex D (informative): Derivation of radiated spurious emissions limit for Band II LPD		48
Annex E (informative): Justifications for field strength measurement.....		49

Annex F (informative):	Bibliography.....	50
History		51

Intellectual Property Rights

IPRs essential or potentially essential to the present document may have been declared to ETSI. The information pertaining to these essential IPRs, if any, is publicly available for **ETSI members and non-members**, and can be found in ETSI SR 000 314: "*Intellectual Property Rights (IPRs); Essential, or potentially Essential, IPRs notified to ETSI in respect of ETSI standards*", which is available from the ETSI Secretariat. Latest updates are available on the ETSI Web server (<http://webapp.etsi.org/IPR/home.asp>).

Pursuant to the ETSI IPR Policy, no investigation, including IPR searches, has been carried out by ETSI. No guarantee can be given as to the existence of other IPRs not referenced in ETSI SR 000 314 (or the updates on the ETSI Web server) which are, or may be, or may become, essential to the present document.

Foreword

This European Standard (Telecommunications series) has been produced by ETSI Technical Committee Electromagnetic compatibility and Radio spectrum Matters (ERM).

Every EN prepared by ETSI is a voluntary standard. The present document may contain text concerning conformance testing of the equipment to which it relates. This text should be considered as guidance only and does not make the present document mandatory.

Annex A provides normative specifications concerning radiated measurements.

Annex B provides a graphic representation of the equipment and frequencies for the testing of single and multi frequency equipment.

Annex C provides informative parameters on the receiver part, which are intended to give guidance to manufacturers.

Annex D provides information on the derivation of radiated emissions limits for Band II LPD.

Annex E provides a justification for field strength limits for Band II LPD

The present document is part 1 of a multi-part deliverable covering cordless audio devices in the range 25 MHz to 2 000 MHz; as identified below:

Part 1: "Technical characteristics and test methods";

Part 2: "Harmonized EN covering essential requirements of article 3.2 of the R&TTE Directive".

National transposition dates	
Date of adoption of this EN:	21 July 2006
Date of latest announcement of this EN (doa):	31 October 2006
Date of latest publication of new National Standard or endorsement of this EN (dop/e):	30 April 2007
Date of withdrawal of any conflicting National Standard (dow):	30 April 2007

Introduction

In preparing the present document, much attention has been given to assure a low interference probability, while at the same time allowing a maximum flexibility and service to the end-user.

The harmonized standard EN 301 357-2 provides the necessary parameters for equipment to obtain common approval throughout Europe. Common technical specifications and harmonized frequency allocations are expected to reduce the present problems of interference and illegal use.

The present document is used for conformity testing based on spectrum utilization parameters and does not include performance characteristics that may be required by the user or requirements for interfacing equipment.

The present document is intended to specify the minimum performance and the methods of measurement of cordless audio equipment in the range 25 MHz to 2 000 MHz, including:

- consumer radio microphones and in ear monitoring equipment in the range 863 MHz to 865 MHz;
- Band II LPD (low power devices) in the 87,5 MHz to 108 MHz range (Broadcasting Band II);
- and other devices and frequency bands defined within REC 70-03 or National regulation.

Consumer radio microphones and in ear monitoring equipment may be tested to either EN 300 422 [4] for equipment with maximum occupied bandwidth <200 kHz or to the present document for equipment with maximum occupied bandwidth >200 kHz with due consideration of power and operating frequency.

1 Scope

The present document covers the minimum characteristics considered necessary in order to make the best use of the available frequencies. It does not necessarily include all the characteristics that may be required by a user, nor does it necessarily represent the optimum performance achievable.

Cordless audio devices covered within the present document are considered by definition short-range devices, the power limits for frequency bands will be found in the current version of CEPT/ERC/REC 70-03, annex 13 (or national regulations).

Stereo equipment can be designed for required channel bandwidths of 200 kHz or less, however consumer wideband (multi channel) audio equipment and stereo equipment using e.g. Zenith-GE pilot tone systems or digital modulation may need wider bandwidths as defined in the present document.

The present document applies to cordless audio consumer radio microphones, in ear monitoring equipment using either 300 kHz bandwidth analogue modulation or:

- 300 kHz, 600 kHz, 1 200 kHz digital FDMA modulation; and
- Band II LPD (low power devices) using 200 kHz bandwidth and analogue modulation.

The frequency bands for this equipment may differ from country to country as specified in their national regulations. All equipment is intended to be used with integral antennas.

Consumer audio equipment intended for audio and voice operating below 50 MHz and using narrow band modulation are considered and tested according to EN 300 220 [6].

Electromagnetic Compatibility (EMC) requirements are covered by EN 301 489-9 [3].

The types of equipment covered by the present document are as follows:

- cordless headphones;
- cordless loudspeakers;
- consumer radio microphones;
- in-ear monitoring;
- in-vehicle cordless;
- personal cordless;
- broadband multi channel audio systems;
- Band II LPD.

2 References

The following documents contain provisions which, through reference in this text, constitute provisions of the present document.

- References are either specific (identified by date of publication and/or edition number or version number) or non-specific.
- For a specific reference, subsequent revisions do not apply.
- For a non-specific reference, the latest version applies.

Referenced documents which are not found to be publicly available in the expected location might be found at <http://docbox.etsi.org/Reference>.

- [1] ITU-R Recommendation BS.559-2: "Objective measurement of radio-frequency protection ratios in LF, MF and HF broadcasting".
- [2] IEC 60244-13: "Methods of measurement for radio transmitters - Part 13: Performance characteristics for FM sound broadcasting".
- [3] ETSI EN 301 489-9: "Electromagnetic compatibility and Radio spectrum Matters (ERM); ElectroMagnetic Compatibility (EMC) standard for radio equipment and services; Part 9: Specific conditions for wireless microphones, similar Radio Frequency (RF) audio link equipment, cordless audio and in-ear monitoring devices".
- [4] ETSI EN 300 422: "Electromagnetic compatibility and Radio spectrum Matters (ERM); Technical characteristics and test methods for wireless microphones in the 25 MHz to 3 GHz frequency range".
- [5] ETSI TR 100 027: "ElectroMagnetic Compatibility and Radio Spectrum Matters (ERM); Methods of measurement for private mobile radio equipment".
- [6] ETSI EN 300 220 (all parts): "Electromagnetic compatibility and Radio spectrum Matters (ERM); Short Range Devices (SRD); Radio equipment to be used in the 25 MHz to 1 000 MHz frequency range with power levels ranging up to 500 mW".
- [7] ETSI TR 102 273 (all parts): "Electromagnetic compatibility and Radio spectrum Matters (ERM); Improvement on Radiated Methods of Measurement (using test site) and evaluation of the corresponding measurement uncertainties".
- [8] ANSI C63.5: "American National Standard for Electromagnetic Compatibility-Radiated Emission Measurements in Electromagnetic Interference (EMI) Control-Calibration of Antennas (9 kHz to 40 GHz)".
- [9] IEC 60489-3: "Methods of measurement for radio equipment used in the mobile services. Part 3: Receivers for A3E or F3E emissions".
- [10] ETSI EN 301 489-1: "Electromagnetic compatibility and Radio spectrum Matters (ERM); ElectroMagnetic Compatibility (EMC) standard for radio equipment and services; Part 1: Common technical requirements".
- [11] Directive 1999/5/EC of the European Parliament and of the Council of 9 March 1999 on radio equipment and telecommunications terminal equipment and the mutual recognition of their conformity (R&TTE Directive).

3 Definitions, symbols and abbreviations

3.1 Definitions

For the purposes of the present document, the following terms and definitions apply:

artificial antenna: tuned reduced-radiating dummy load equal to the nominal impedance specified by the applicant

channel bandwidth: frequency band of defined width including safety margin for operation on adjacent channels, located symmetrically around the carrier frequency

integral antenna: antenna, with or without a connector, designed as, and declared as by the manufacturer, an indispensable part of the equipment

integral antenna for Band II LPD only: permanent fixed antenna, which may be built-in, designed as an indispensable part of the equipment

necessary bandwidth: is, for a given class of emission, the width of the frequency band which is just sufficient to ensure the transmission of information at the rate and with the quality required under specified conditions

NOTE: However, the necessary bandwidths of most digital modulation formats are presently not referred to ITU-R Recommendations of SM series.

occupied bandwidth: width of a frequency band such that, below the lower and above the upper frequency limits, the mean powers emitted are each equal to a specified percentage $\beta/2$ of the total mean power of a given emission.

NOTE: Unless otherwise specified in an ITU-R Recommendation for the appropriate class of emission, the value of $\beta/2$ should be taken as 0,5%.

port: any connection point on or within the Equipment Under Test (EUT) intended for the connection of cables to or from that equipment

radiated measurements: measurements that involve the absolute measurement of a radiated electromagnetic field

spurious emission: emission on a frequency or frequencies which are outside the necessary bandwidth and the level of which may be reduced without affecting the corresponding transmission of information. Spurious emissions include harmonic emissions, parasitic emissions, intermodulation products and frequency conversion products.

3.2 Symbols

For the purposes of the present document, the following symbols apply:

λ	wavelength in metres
μF	micro Farad
μW	micro Watt
Ω	ohm
dBc	dB relative to the carrier level
E	field strength
f_c	carrier frequency
f_o	operating frequency
GHz	Giga Hertz
kHz	kilo Hertz
MHz	Mega Hertz
mW	milli Watt
nW	nano Watt

3.3 Abbreviations

For the purposes of the present document, the following abbreviations apply:

ac	alternating current
B	channel Bandwidth
BN	Necessary Bandwidth
CW	Continuous Wave
dc	direct current
erp	effective radiated power
EUT	Equipment Under Test
FDMA	Frequency Division Multiple Access
FM	Frequency Modulation
HF	High Frequency
LF	Low Frequency
LPD	Low Power Device
MF	Medium Frequency
OATS	Open Area Test Site
RBW	Resolution BandWidth
RF	Radio Frequency
SINAD	(Signal + Noise + Distortion) to (Noise + Distortion)
SRD	Short Range Devices
Tx	Transmitter
VBW	Video BandWidth
VSWR	Voltage Standing Wave Ratio

4 Functional characteristics

4.1 Cordless audio

Cordless audio equipment encompasses e.g. radio linked headphones and loudspeakers. The transmitters may be installed in a building, fitted in a vehicle or body worn. The term cordless is also used to describe infra red and other non-RF "wireless" links, but in the context of the present document it is restricted to RF operating systems only. Stereo equipment can be designed for required channel bandwidths of 200 kHz or less, however consumer wideband (multi channel) audio equipment and stereo equipment using e.g. Zenith-GE pilot tone systems or digital modulation may need wider bandwidths as defined in the present document.

Other equipment that may be connected to cordless audio equipment shall fulfil the standards applicable to that equipment (if any).

4.1.1 In-vehicle cordless

In-vehicle systems are used for private listening in automobiles and other methods of transport (where permitted).

4.1.2 Personal cordless

Personal cordless transmitters are to enable the body worn personal stereo equipment to be wire free.

4.1.3 Broadband multi channel systems

Broadband multi channel systems are used for the transmission of high quality digital audio. These can be e.g. surround sound systems or uncompressed audio. They are intended to be used in spectrum above 1 GHz.

4.1.4 Band II LPD

Short range low power FM transmitters operating in the FM Broadcast band 88 MHz to 108 MHz are used for the provision of an rf link between a personal audio device, including mobile phone, and the in-car or home entertainment system.

4.2 Consumer radio microphones

Consumer radio microphones are intended for non-professional applications.

4.3 In-ear monitoring

In-ear monitoring equipment is used by stage and studio performers to receive personal fold back (monitoring) of the performance. This can be just their own voice or a complex mix of sources. This equipment is usually stereo or 2 channel audio.

Other equipment that may be connected to in-ear monitoring equipment shall fulfil the standards applicable to that equipment (if any).

5 General

5.1 Presentation of equipment for testing purposes

Each equipment submitted for performance testing shall fulfil the requirements of the present document on all channels over which it is intended to operate.

The applicant shall complete the appropriate application form or test plan when submitting equipment for testing.

The applicant shall state the channel bandwidth(s) within which the equipment is designed to operate.

The applicant shall also supply all relevant interface information and any tools and test fixtures to allow:

- direct current (dc) power connection;
- analogue audio connection;
- the deviation limiting of the transmitter; and
- the setting of any input audio level controls and input signal level for normal operation, for a sinusoidal input signal of 500 Hz (or 1kHz in the case of Band II LPD). The manufacturer shall specify the settings of any other controls necessary to avoid invalidating the test measurements.

In the case of Band II LPD it may be necessary for integrated equipment to create a stored data file of 1 kHz stereo sinusoidal tones to stimulate the input to the transmitter. The amplitude of such tones should be variable (but the same amplitude for each tone) to enable the correct adjustment of ± 75 kHz FM deviation of the transmitter output.

Besides the technical documentation, the applicant should also supply an operating manual, identical in content to that supplied with the production model(s) available to the public, for the device(s).

To simplify and harmonize the testing procedures between manufacturers and test laboratories, measurements shall be performed, according to the present document, on samples of equipment defined in clauses 5.1.1 to 5.1.9.2.

These clauses are intended to give confidence that the requirements set out in the present document have been met without the necessity of performing measurements on all channels.

5.1.1 Choice of model for performance testing

The applicant shall provide one sample of each model to be tested.

The equipment tested shall be representative in all technical respects of a production model.

5.1.2 Definitions of alignment and switching ranges

The alignment range is defined as the frequency range over which the receiver and the transmitter can be programmed and/or re-aligned to operate with a single oscillator frequency multiplication, without any physical change of components other than:

- programmable read only memories supplied by the manufacturer or the manufacturer's nominee;
- crystals;
- frequency setting elements (for the receiver and transmitter). These elements shall not be accessible to the end user and shall be declared by the applicant in the application form.

The switching range is the maximum frequency range over which the receiver or the transmitter can be operated without re-programming or realignment.

The applicant shall, when submitting equipment for test, state the alignment ranges for the receiver and transmitter. The applicant shall also state the switching range of the receiver and the transmitter (which may differ).

In the case of Band II LPD the transmitter frequency range shall be limited to 87,6 MHz to 107,9 MHz.

5.1.3 Alignment Range

The alignment range for the receiver and transmitter, which may be different, shall be within the applicable band.

5.1.4 Choice of frequencies

The frequencies for testing shall be chosen by the applicant, in accordance with clauses 5.1.5 to 5.1.7.

In the case of Band II LPD the transmitter carrier frequency shall be between 87,6 MHz to 107,9 MHz and the frequency producing the highest radiated output power shall be chosen.

5.1.5 Testing of single channel equipment

Full tests shall be carried out on a channel within B/2 of the centre frequency of the alignment range on one sample of the equipment (B = declared channel bandwidth).

5.1.6 Testing of two channel equipment

One sample shall be submitted to enable tests to be carried out on both channels.

The frequency of the upper channel shall be within B/2 of the highest frequency of the switching range. The frequency of the lower channel shall be within B/2 of the lowest frequency of the switching range. In addition, the average of the frequencies of the two channels shall be within B/2 of the centre frequency of the alignment range.

Full tests shall be carried out on both channels.

5.1.7 Testing of multi-channel equipment (more than two channels)

One sample of the equipment shall be submitted to enable tests to be carried out on three channels. The centre frequency of the switching range of the sample shall correspond to the centre frequency of the alignment range.

Full tests shall be carried out on a frequency within B/2 of the centre, lowest and highest frequencies of the switching range.

5.1.8 Testing of equipment with an external frequency control

One sample shall be submitted to enable tests to be performed across the entire frequency band allowed by the frequency control setting.

The following tests shall be performed at either edge of the tuneable range of the equipment:

- clause 8.3: Frequency error;
- clause 8.4: Carrier power;
- clause 8.5: Channel bandwidth.

The following tests shall be performed with the frequency set to the middle of the tuneable range of the equipment:

- clause 8.6: Spurious emissions;
- clause 8.7: Transmitter shutoff.

5.1.9 Testing of equipment with an integral antenna

To facilitate relative measurements, use may be made of a test fixture as described in clause 7.2, or the equipment may be supplied with a permanent internal or temporary internal/external RF port.

This clause does not apply to Band II LPD.

5.1.9.1 Equipment with a permanent internal RF port

The way to access a permanent internal RF port shall be stated by the applicant with the aid of a diagram. The fact that use has been made of a permanent internal RF port shall be recorded in the test report.

5.1.9.2 Equipment with a temporary RF port

The applicant shall submit two sets of equipment to the test laboratory, one fitted with a temporary 50 Ω RF connector with the antenna disconnected and the other with the antenna connected. Each equipment shall be used for the appropriate tests.

The way the temporary RF port is implemented shall be stated by the applicant with the aid of a diagram. The fact that use has been made of the temporary RF port to facilitate measurements shall be stated in the test report. The addition of a temporary RF port should not influence the performance of the EUT.

5.2 Mechanical and electrical design

5.2.1 General

The equipment submitted by the applicant shall be designed, constructed and manufactured in accordance with sound engineering practice, and with the aim of minimizing harmful interference to other equipment and services and minimizing risk of physical injury to the user when in use or having to gain access to batteries or controls.

5.2.2 Controls

Those controls that, if maladjusted, might increase the interfering potentialities of the equipment shall only be accessible by partial or complete disassembly of the device and requiring the use of special tools.

5.2.3 Integral antenna

Conformity testing of equipment with integral antenna only applies to that equipment together with the antenna originally provided by the manufacturer for type testing.

5.2.4 Marking

The equipment shall be marked in a visible place. This marking shall be legible and durable. The marking shall be according to the R&TTE Directive [11].

5.3 Interpretation of the measurement results

The interpretation of the results recorded in the appropriate test report for the measurements described in the present document shall be as given in clause 10.

6 Test conditions, power sources and ambient conditions

6.1 Normal and extreme test-conditions

Performance tests shall be made under normal test conditions, and also, where stated, under extreme test conditions.

The test conditions and procedures shall be as specified in clauses 6.2 to 6.4.2.4.

6.2 Test power source

During performance tests the power source of the equipment may be replaced by a test power source, capable of producing normal and extreme test voltages as specified in clauses 6.3.2 and 6.4.2. The internal impedance of the test power source shall be low enough for its effect on the test results to be negligible. For the purpose of the tests, the voltage of the power source shall be measured at the input terminals of the equipment.

For battery-operated equipment, the battery may be removed and the test power source shall be suitably decoupled and applied as close to the equipment battery terminals as practicable. For radiated measurements any external power leads should be arranged so as not to affect the measurements. If necessary the external power supply may be replaced with the equipment's own internal batteries at the required voltage, this shall be stated on the test report.

If the equipment is provided with a power cable or power socket, the test voltage shall be that measured at the point of connection of the power cable to the equipment.

During tests the power source voltages shall be within a tolerance of $< \pm 1$ % relative to the voltage at the beginning of each test. The value of this tolerance can be critical for certain measurements. Using a smaller tolerance provides a better uncertainty value for these measurements. If internal batteries are used, at the end of each test the voltage shall be within a tolerance of $< \pm 1$ % relative to the voltage at the beginning of each test.

6.3 Normal test conditions

- a) Test environment:
 - the normal operating environment, as declared by the equipment manufacturer; and
 - the normal operational power supply, as declared by the manufacturer.
- b) Test frequencies:
 - the lowest operating frequency;
 - the highest operational frequency; and
 - a frequency mid-way between the lowest and highest operational frequency.

No further temperature and power source testing is required for these devices.

6.3.1 Normal temperature and humidity

The normal temperature and humidity conditions for tests shall be any convenient combination of temperature and humidity within the following ranges:

- temperature: +15°C to +35°C;
- relative humidity: 20 % to 75 %.

When it is impracticable to carry out the tests under the conditions stated above, a note to this effect, stating the actual temperature and relative humidity during the tests, shall be added to the test report.

6.3.2 Normal test power source voltage

6.3.2.1 Mains voltage

The normal test voltage for equipment to be connected to the mains shall be the nominal mains voltage. For the purpose of the present document, the nominal voltage shall be the declared mains voltage, or any of the declared mains voltages, for which the equipment was designed.

The frequency of the test power source corresponding to the alternating current (ac) mains shall be between 49 Hz and 51 Hz.

6.3.2.2 Nickel-cadmium cells

When the radio equipment is intended for operation from the usual types of nickel-cadmium cell the nominal test voltage shall be 1,2 V per cell.

6.3.2.3 Other power sources

For operation from other power sources or types of battery (primary or secondary), the normal test voltage shall be that declared by the equipment manufacturer, in equipment handbook and approved by the test laboratory. The values shall be stated in the test report.

6.4 Extreme test conditions

There are no requirements for testing Band II LPD under extreme test conditions.

6.4.1 Extreme temperatures

For tests at extreme temperatures, measurements shall be made in accordance with the procedures specified in clause 6.4.1.1, at a temperature range declared by the manufacturer.

6.4.1.1 Procedures for tests at extreme temperatures

Before measurements are made the equipment shall have reached thermal balance in the test chamber. The equipment shall be switched off during the temperature stabilizing period. If the thermal balance is not checked by measurements, a temperature-stabilizing period of at least one hour shall be allowed.

The sequence of measurements shall be chosen and the humidity content in the test chamber shall be controlled so that excessive condensation does not occur.

Before tests at the higher temperatures, the equipment shall be placed in the test chamber and left until thermal balance is attained. The equipment shall then be switched on for one minute in the transmit condition, after which the equipment shall meet the specified requirements.

For tests at the lower extreme temperature the equipment shall be left in the test chamber until thermal balance is attained, then switched to the standby or receive condition for one minute after which the equipment shall meet the specified requirements.

6.4.2 Extreme test power source voltages

6.4.2.1 Mains voltage

The extreme test voltages for equipment to be connected to an ac mains source shall be the nominal mains voltage $\pm 10\%$.

The frequency of the test power source corresponding to the ac mains shall be between 49 Hz and 51 Hz.

6.4.2.2 Re-chargeable battery power sources

When the radio equipment is intended for operation from nickel-cadmium cells, the extreme test voltage shall be 1,3 and 0,9 times the nominal voltage of the battery. For other types of battery the lower extreme test voltage for discharged condition shall be declared by the equipment manufacturer.

6.4.2.3 Power sources using other types of batteries

The lower extreme test voltages for equipment with power sources using primary batteries shall be as follows:

- for Leclanché or lithium type of battery:
 - 0,85 times the nominal voltage of the battery;
- for mercury type of battery:
 - 0,9 times the nominal voltage of the battery;
- for other types of primary batteries:
 - end-point voltage declared by the equipment manufacturer.

The nominal voltage is considered to be the upper extreme test voltage in this case.

6.4.2.4 Other power sources

For equipment using other power sources, or capable of being operated from a variety of power sources, the extreme test voltages shall be those agreed between the equipment manufacturer and the testing laboratory and shall be recorded with the results.

7 General conditions

Clauses 7.1 to 7.5 do not apply to Band II LPD.

7.1 Normal test modulation

The normal test modulation to produce the declared nominal deviation shall be a sinusoidal tone of 500 Hz, set at an input audio level to the transmitter as defined by the manufacturer.

In the case of systems with a digital audio input this test signal has to be presented via a suitable test fixture.

The applicant shall provide details on the interface and test fixture used for the test.

For the purpose of determining the transmitter necessary bandwidth, coloured noise according to ITU-R Recommendation BS.559-2 [1] shall be used, according to the method laid down in clause 8.3.2. The resulting spectral distribution is shown in figure 1. This noise may be generated by a white noise source followed by a passive filter shown in figure 2.

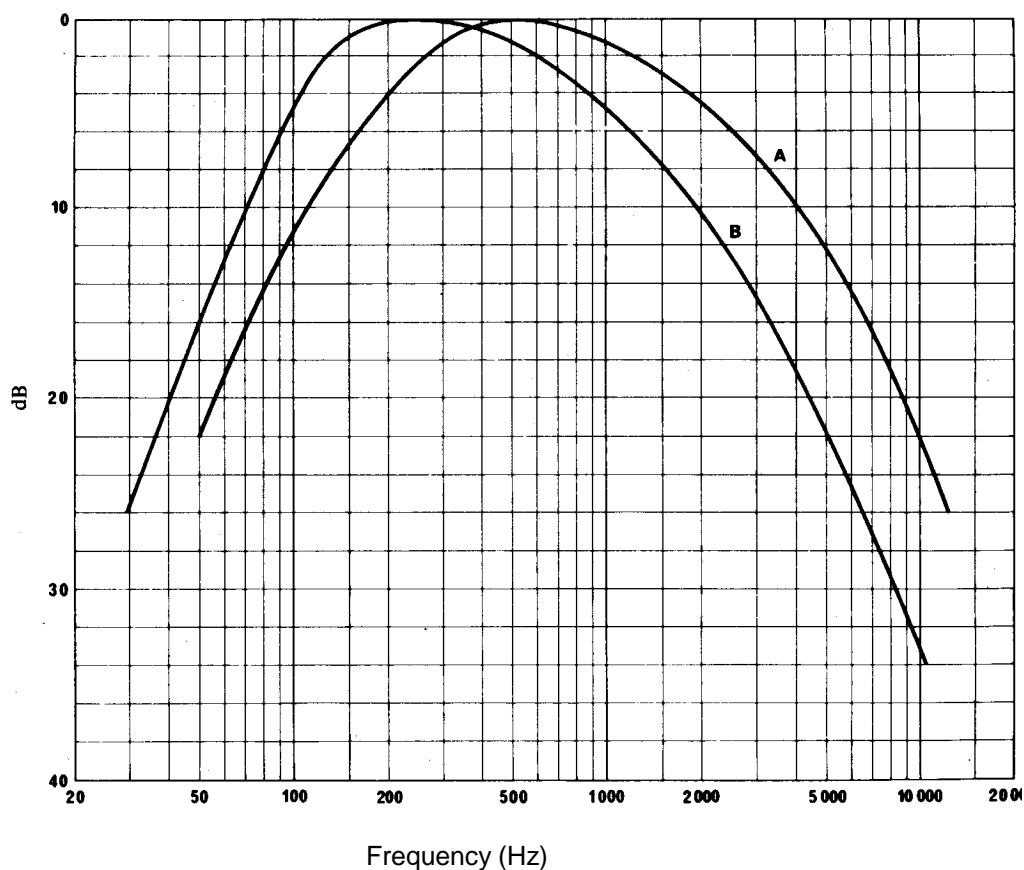

Curve A = Frequency spectrum of standardized noise (measured with one-third octave filters).
 Curve B = Frequency response characteristics of filter circuit.

Figure 1: Spectral distribution for determining transmitter necessary bandwidth

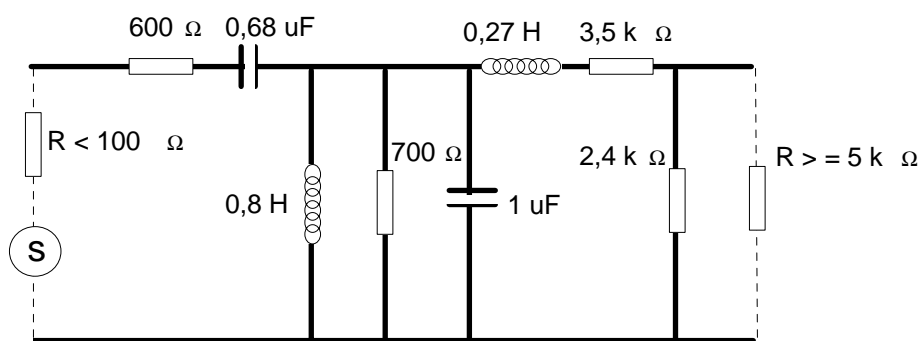

Figure 2: Filter circuit

7.2 Test fixture

The applicant may be required to supply a test fixture suitable to allow relative measurements to be made on the submitted sample, particularly in the case of digital equipment.

In all cases, the test fixture shall provide:

- a connection to an external power supply;
- an analogue audio interface (in the case of digital systems this can be a complex interface).

In addition, the test fixture for integral antenna equipment shall contain a radio frequency coupling device associated with an integral antenna equipment for coupling the integral antenna to an RF port at the working frequencies of the EUT. This allows certain measurements to be performed using the conducted measurement methods. Only relative measurements may be performed and only those at or near frequencies for which the test fixture has been calibrated.

The performance characteristics of the test fixture shall be agreed upon with the accredited test laboratory and shall conform to the following basic parameters:

- the circuitry associated with the RF coupling shall contain no active or non-linear devices;
- the coupling loss shall not influence the measuring results;
- the coupling loss shall be independent of the position of the test fixture and be unaffected by the proximity of surrounding objects or people;
- the coupling loss shall be reproducible when the EUT is removed and replaced;
- the coupling loss shall remain substantially constant when the environmental conditions are varied.

7.3 Test site and general arrangements for radiated measurements

For guidance on radiation test sites, see annex A. Detailed descriptions of the radiated measurement arrangements are included in annex A.

7.4 Modes of operation of the transmitter

For the purpose of the measurements according to the present document there should preferably be a facility to operate the transmitter in an unmodulated state. The method of achieving an unmodulated carrier frequency or special types of modulation patterns may also be decided by agreement between the manufacturer and the testing laboratory. It shall be described in the test report. It may involve suitable temporary internal modifications of the EUT. Should it not be possible to produce an unmodulated signal, the peak envelope power is to be measured. The manufacturer shall specify in accordance with clauses 8.4 and 8.5.

7.5 Arrangement for test signals at the input of the transmitter

For the purpose of the present document, the appropriate audio frequency input signal to produce the manufacturer's declared nominal deviation shall be supplied by a generator at the correct impedance applied at the connections of the stated audio input, unless otherwise stated.

For digital systems a nominal input level, as specified in clause 7.1, shall be supplied by a generator at the correct impedance applied at the connections of the stated audio input of the test fixture.

8 Methods of measurement and limits for transmitter parameters

All tests shall be carried out under normal conditions unless otherwise stated.

8.1 Basic requirements for Band II LPD

The following conditions shall be met by all Band II LPD:

- Band II LPD shall cease to transmit within 1 minute of the removal of audio modulation.
- Band II LPD shall have an "integral antenna" (Refer to 3.1 Definitions: "integral antenna for Band II LPD only").

- Band II LPD shall operate on user selectable frequencies within the 87,6 MHz to 107,9 MHz frequency range. Channel selection by the device within the stated frequency range is also permitted.
- A test mode may be provided for measurements to allow continuous carrier transmission without the need for a modulating audio frequency input signal.

8.2 Methods of measurement and limits for transmitter parameters of Band II LPD

The following clauses specify the individual test requirements and limits for compliance to the present document.

The radiated power and radiated spurious emissions measurements shall be carried out in both vertical and horizontal polarization of the measurement antenna.

8.2.1 Effective radiated power, occupied bandwidth, channel spacing, frequency error, and transmitter timeout

8.2.1.1 Definitions

The radiated power is defined as the carrier power that the transmitter radiates according to manufacturers specified conditions of operation.

The transmitter occupied bandwidth is defined as that radiated transmitter bandwidth that complies with the channel bandwidth and out of band emissions requirements. It is normally defined as a transmitter mask.

Channel spacing is defined as the frequency step size when changing frequency between two adjacent channels.

Frequency error is defined as the difference in Hz between the nominal channel frequency and the actual transmitted frequency of the unmodulated carrier.

The transmitter timeout is the time from the moment where the audio input signal is removed until the transmitter stops to transmit or reduces the radiated power to max. 3 nW ERP.

8.2.1.2 Test equipment setup

The test receiver/spectrum analyser shall be set as follows:

- resolution bandwidth = 10 kHz;
- video bandwidth = > 30 kHz; and
- frequency span = 500 kHz;
- detector = Quasi Peak.

8.2.1.3 Method of measurement

8.2.1.3.1 Test site and general arrangements for radiated measurements

It is recommended that the test measurements are made at a separation distance of 3 metres within a fully lined anechoic chamber. The test antenna shall be aligned at a height of 1,5 metres with the EUT antenna that has been placed upon a rotating turntable at the same height.

NOTE: This test would normally be performed at a distance of 10 m, where feasible. However, due to the difficulty of measuring low power devices on an Open Area Test Site (OATS) the measurements can be carried out at other distances within a fully lined anechoic chamber. In this case the compliance limits are modified according to the relation:

- $\text{Limit (xm)} = \text{Limit (10m)} + 20 \log (10/x)$;
- where $x = \text{distance}$.

The dimensions of the integral transmitter antenna would normally be less than $\lambda/10$ and therefore the separation distance at 3 metres is better than $2(d^2)/\lambda$ and as a consequence can be considered as being in the far field.

See annex D and annex E for additional information.

8.2.1.3.2 Test modulation

The EUT shall be modulated by a 1 kHz sinusoidal tone, fed to each stereo channel input, at a level, as specified by the manufacturer, to give a ± 75 kHz FM deviation of the transmitter output.

NOTE: It may be necessary for integrated (or combined) equipment to create a stored data file of 1 kHz stereo or mono sinusoidal tones (equal amplitudes for stereo) to stimulate the input to the transmitter. The amplitude of such tones should be variable to enable the correct adjustment of ± 75 kHz FM deviation of the transmitter output.

8.2.1.3.3 Measurement procedure

The tests are carried out at the frequency producing the highest output power.

Interrupt the modulation to the transmitter and measure the carrier power at the test frequency on the measuring receiver/spectrum analyser.

NOTE: The interruption of the audio input allows the FM carrier power to be measured on the measuring receiver/spectrum analyser.

The transmitter mask shall be recorded on the test frequency whilst the transmitter is modulated by the normal test modulation according to clause 8.2.1.3.2.

The frequency shall be stepped one channel and the frequency change shall be measured and recorded as channel spacing.

At the test frequency the time between the interruption of the audio and the shut down of the transmitter shall be measured. The shutdown time shall be recorded. The radiated power shall not exceed 3 nW ERP in the shut down mode.

8.2.1.4 Limits

The transmitter shall cease to transmit within 1 minute on removal of the audio input signal.

The radiated RF power, the frequency error and the channel spacing shall conform with the limits given in table 1.

Table 1: Limits for effective radiated power, frequency error and channel spacing

Radiated power limit	Frequency error	Channel spacing
50 nW erp (-43 dBm erp)	max. ± 10 kHz	100 kHz

The transmitter mask shall conform to table 2.

Table 2: Transmitter mask

Offset from carrier frequency	Radiated emission limit (erp)
-120 kHz	3 nW (see note)
-75 kHz	50 nW
-50 kHz	50 nW
0	50 nW
+50 kHz	50 nW
+75 kHz	50 nW
+120 kHz	3 nW (see note)
NOTE: See annex D for the derivation of this limit. The Radiated emission may be measured as electrical field strength and the result may be converted to ERP assuming far field conditions (see annex E).	

8.2.1.5 Measurement uncertainty

The maximum acceptable measurement uncertainty for time shall be ± 10 seconds.

The maximum acceptable measurement uncertainty for radiated RF power shall be ± 6 dB.

The maximum acceptable measurement uncertainty for frequency error shall be ± 100 Hz.

8.2.1.6 Radiated spurious emissions

8.2.1.6.1 Definitions

Spurious emission: see clause 3.1.

8.2.1.6.2 Measurement procedure

Install the transmitter in accordance with clause 8.2.1.3.1.

The transmitter shall be set to the frequency producing the highest spurious output power.

The spurious emissions shall be measured and reported over the frequency range 30 MHz to 1 GHz.

8.2.1.6.3 Limits for Band II LPD

- Maximum 3 nW (-55,2 dBm) erp to be applied at all frequencies except at the transmitter carrier frequency and the associated modulation components identified under clause 8.2.1.4 and table 2; or
- Maximum 30 dBuV/m at 10 m for electrical field strength (see annex D and annex E).

8.2.1.6.4 Limits for combined equipments

For combined equipment, such as Band II LPD implemented in cellular phones or in other telecommunication equipment, the erp measurement of spurious emissions may be made according to the matching EN for the main equipment. (e.g. EN 301 908-1 for UMTS, EN 301 511 for GSM etc.) Any contribution from the spurious emissions of the integrated Band II LPD is most conveniently measured in the same test configuration and against the limits of the main equipment. Apply the idle mode erp limits of the main equipment to the Band II LPD with provisions for an exclusion band around the wanted signal. The maximum acceptable measurement uncertainty shall apply as specified in the appropriate EN for the main equipment.

8.2.1.6.5 Measurement uncertainty

The maximum acceptable measurement uncertainty shall be ± 6 dB.

8.3 Frequency error

This clause does not apply to Band II LPD.

8.3.1 Definition

The frequency error of the transmitter is the difference between the unmodulated carrier frequency measured under normal conditions and its value measured under extreme conditions.

In the case of transmitters that are incapable of producing an unmodulated carrier, the mean of two frequency measurements taken at the same level on the upper and lower sides of the modulation envelope shall be taken as the measurement value.

8.3.2 Method of measurement

The carrier frequency shall be measured with the transmitter placed in a test fixture (see clause 7.2) connected to an artificial antenna. For equipment with an external frequency control the nominal frequencies are taken as the measured frequency under normal test conditions at each end of the tuning range (see clause 8.5.4).

The measurement shall be made under normal test conditions (see clause 6.3), and extreme test conditions (clauses 6.4.1 and 6.4.2 applied simultaneously).

8.3.3 Limit

The limits for the frequency error over the normal and extreme temperature range are given in table 3.

Table 3: Limits on frequency error

Frequencies below 1 GHz	Frequencies above 1 GHz
±60 ppm	±35 ppm

8.4 Carrier power

This clause does not apply to Band II LPD.

8.4.1 Definition

The transmitter carrier power is defined as the effective radiated power in the direction of maximum field strength, under specified conditions of measurement, (see clauses 7.4 and 7.5), if possible in the absence of modulation. The stated output power is the carrier power declared by the manufacturer.

8.4.2 Method of measurement for equipment with integral antenna

8.4.2.1 Method of measurement under normal test conditions

On a test site fulfilling the requirements of clause 7.3, the sample shall be placed on the support in the following position:

- for equipment with an internal antenna, it shall stand vertically, with that axis vertical which is closest to vertical in normal use;
- for equipment with rigid external antenna, the antenna shall be vertical;
- for equipment with a non-rigid external antenna, with the antenna extended vertically upwards by a non-conducting support.

The transmitter shall be switched on, without modulation, and the test receiver shall be tuned to the frequency of the signal being measured. The test antenna shall be oriented for vertical polarization and shall be raised or lowered through the specified height range until a maximum signal level is detected on the test receiver. The test antenna shall then be oriented for horizontal polarization and raised or lowered through the specified height range until a maximum signal level is detected on the test receiver. For transmitters that are incapable of producing an unmodulated carrier (CW), the transmitter peak power shall be measured, using a spectrum analyser that is able to display the peak enveloped power either via a special function calculation, a correction factor to be used or by any other means. The applicant shall state the method used.

The transmitter shall be rotated horizontally through 360° until the highest maximum signal is received.

NOTE: This maximum may be a lower value than the value obtainable at heights outside the specified limits.

The transmitter shall be replaced by a substitution antenna, as defined in clause A.1.3 and the test antenna raised or lowered as necessary to ensure that the maximum signal is still received. The input signal to the substitution antenna shall be adjusted in level until an equal or a known related level to that detected from the transmitter is obtained in the test receiver.

The carrier power is equal to the power supplied to the substitution antenna, increased by the known relationship if necessary.

A check should be made in the horizontal plane of polarization to ensure that the value obtained above is the maximum. If larger values are obtained, this fact should be recorded in the test report.

For transmitters that are incapable of producing an unmodulated carrier, the transmitter RF peak envelope power shall be measured, using a spectrum analyser with the following settings.

Table 4: Carrier power measurement parameters

	Frequencies below 1 GHz	Frequencies above 1 GHz
Centre frequency	fc: transmitter (Tx) nominal frequencies	
Dispersion (span)	fc - 1 MHz to fc + 1 MHz	fc - 3 MHz to fc + 3 MHz
Resolution bandwidth (RBW)	1 MHz	3 MHz
Video bandwidth (VBW)	1 MHz	3 MHz
Analyser detector mode	Peak	
Analyser display mode	peak hold	

8.4.2.2 Method of measurement under extreme test conditions

The equipment shall be placed in a test fixture (see clause 7.2) and the relative power deviation delivered to the artificial antenna shall be measured. The measurement shall be made under normal test conditions (see clause 6.3) and extreme test conditions (clauses 6.4.1 and 6.4.2 applied simultaneously).

8.4.3 Limit

The carrier power under normal test conditions (see clause 6.3) and extreme test conditions (see clause 6.4), (clauses 6.4.1 and 6.4.2 applied simultaneously) shall not exceed the limits in table 5.

Table 5: Carrier power

Equipment	Max erp	Freq. band
Cordless audio	10 mW	863 MHz to 865 MHz
In-ear monitoring	10 mW	
In-vehicle cordless	2 mW	
Personal cordless	1 mW	
Consumer radiomicrophones	10 mW	
Applications above 1 GHz	25 mW	Above 1 GHz

Other frequency bands may refer to CEPT/ERC/REC 70-03 or national legislation.

The power of the test sample under normal test conditions shall be within ± 3 dB of the power level declared by the applicant, without exceeding the values in table 5. The declared and measured levels shall be recorded in the test report.

8.5 Channel bandwidth

This clause does not apply to Band II LPD.

8.5.1 Definition

For the purpose of the present document the channel bandwidth (B) is defined as the maximum bandwidth, within which the transmitter's necessary bandwidth (BN) is contained. The necessary bandwidth of the transmitter shall be measured under the conditions given in clause 8.5.2.

8.5.2 Measurement of Necessary Bandwidth (BN)

With a weighted noise source to ITU-R Recommendation BS.559-2 [1], band-limited to 15 kHz as described in IEC 60244-13 [2], the audio input level to the EUT shall be adjusted to give the manufacturer's declared nominal deviation as measured by a deviation meter. If no nominal deviation is declared the stated 500 Hz nominal audio input level shall be used for the weighted noise input level. Digital systems shall be tested via a defined test fixture, the analogue input signal shall be presented to the test fixture. The audio input level shall be increased until a maximum peak deviation reading is obtained on a deviation meter.

The input level is then increased by 10 dB. The transmitter RF output spectrum shall be measured, using a spectrum analyser with the settings given in table 6.

Table 6: Necessary bandwidth, measurement parameters

	Frequencies below 1 GHz	Frequencies above 1 GHz
Centre frequency	fc: transmitter (TX) nominal frequencies	
Dispersion (span)	fc - 1 MHz to fc + 1 MHz	fc - 3 MHz to fc + 3 MHz
Resolution bandwidth (RBW)	1 kHz	1 kHz
Video bandwidth (VBW)	1 kHz	1 kHz
Analyser detector mode	peak	
Analyser display mode	peak hold	
NOTE 1: If the transmitter incorporates any ancillary coding or signalling channels (e.g. pilot-tones), these should be enabled prior to any spectral measurements.		
NOTE 2: If the transmitter incorporates more than one audio input, e.g. stereo systems, the second and subsequent channels should be simultaneously driven from the same noise source, attenuated to a level of -16 dB relative to the primary input.		
NOTE 3: The reference level of the spectrum analyser shall be referred to as the unmodulated (CW) level. Equipment that cannot be put in this position shall use the peak power level as derived with e.g. a spectrum analyser special function calculation, a correction factor to declare or by any other means. The applicant shall state the method used.		

8.5.3 Limits

The transmitter output spectrum shall be within the mask defined in figure 3 or 4 where B is the channel bandwidth.

8.5.4 Edge of Band Limits

At no time, any part of the occupied bandwidth mask shall fall above the values in table 7.

Table 7: Edge of band spectrum limits

	For equipment below 1 GHz	For equipment above 1 GHz
At the allocated frequency band edges, the measured level with an average detector < to both values:	-46 dBc	-50 dBc

For switched frequency equipment the switching range shall be limited so that this condition is met allowing for the maximum frequency error measured under normal or extreme test conditions in clause 8.3.

For equipment with an external frequency control the tuning range shall be limited so that this condition is met allowing for the maximum frequency error measured under normal or extreme test conditions in clause 8.3.

The modes of operation as stated in clause 7.4 apply.

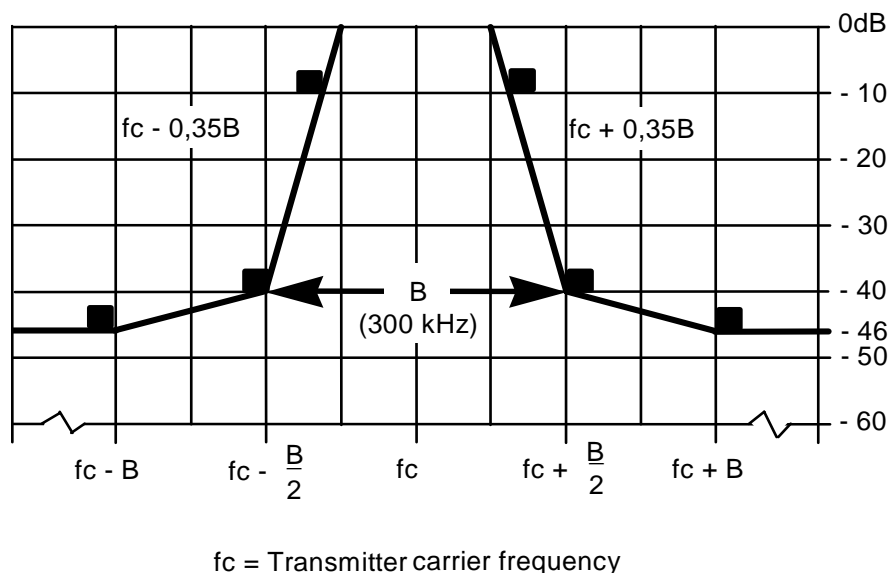

Figure 3: Spectral mask for analogue or digital modulation with $B = 300$ kHz

The measurement of Tx broadband noise floor shall be carried out in accordance with clause 8.5.2. The -46 dBc point shall be ± 300 kHz from f_c measured with an average detector.

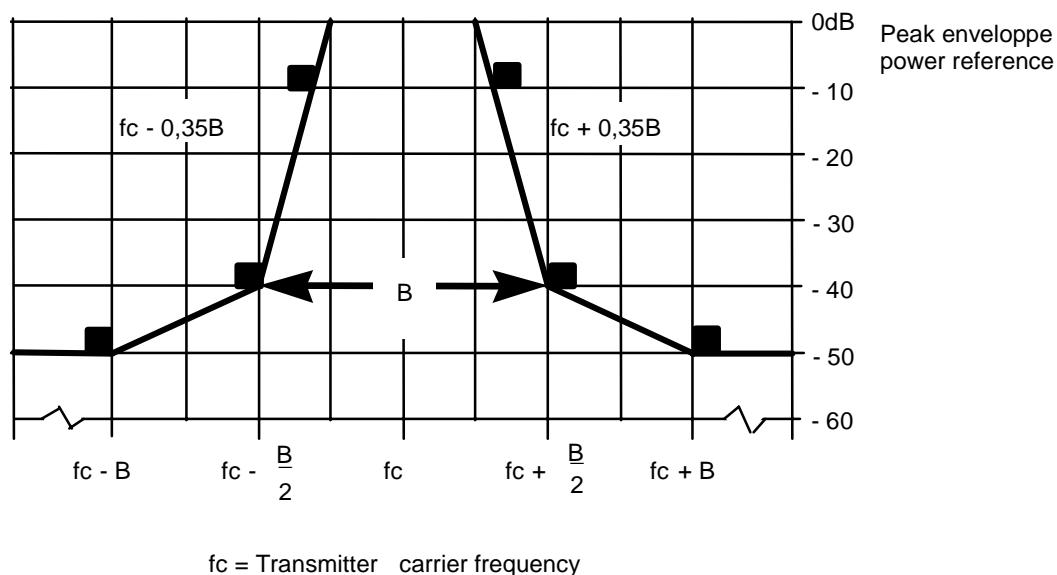

Figure 4: Scaleable Spectral mask for digital modulation with $B = 600$ kHz, $1\ 200$ kHz

The measurement of Tx broadband noise floor shall be carried out in accordance with clause 8.5.2. The -50 dBc point shall be $\pm B$ kHz from f_c measured with an average detector.

8.6 Spurious emissions and cabinet radiation

For Band II LPD equipment refer to clause 8.2.1.6.

8.6.1 Definitions

Spurious emissions: see clause 3.1.

8.6.2 Method of measuring the effective radiated power

On a test site fulfilling the requirements of annex A, the sample shall be placed at the specified height on a non-conducting support. The transmitter shall be operated at the carrier power as specified under clause 8.4 without modulation, where possible.

Radiation of any spurious components shall be detected by the test antenna and receiver, over the frequency range specified below, excluding a band of frequencies of 2 x Bandwidth B centred on the channel on which the transmitter is intended to operate.

NOTE: The exclusion band is covered by measurements carried out in clause 8.5.3.

The measuring receiver shall be tuned over the frequency range given in table 8.

Table 8: Frequency range

Fundamental frequency range	lower frequency	upper frequency
9 kHz to 100 MHz	9 kHz	1 GHz
100 MHz to 300 MHz	9 kHz	10 th harmonic
300 MHz to 600 MHz	30 MHz	3 GHz
600 MHz to 5,2 GHz	30 MHz	5 th harmonic

The test should include the entire harmonic band and not be truncated at the precise upper frequency limit stated.

At each frequency at which a component is detected, the sample shall be rotated to obtain maximum response and the effective radiated power of that component determined by a substitution measurement.

If the transmitter allows for stand-by operation the tests shall be repeated with the transmitter in standby mode.

8.6.3 Limits

The power of the spurious emissions shall not exceed the limits of table 9.

Table 9: Radiated measurements

State	Frequency		
	47 MHz to 74 MHz 87,5 MHz to 118 MHz 174 MHz to 230 MHz 470 MHz to 862 MHz	Other Frequencies below 1 000 MHz	Frequencies above 1 000 MHz
Operation	4 nW	250 nW	1 µW
Standby	2 nW	2 nW	20 nW

8.6.4 Measuring receiver

The term measuring receiver refers to either a selective voltmeter or a spectrum analyser using a peak detector. The bandwidth of the measuring receiver is given in table 10.

Table 10: Measuring receiver bandwidth

Frequency being measured	Measuring receiver bandwidth
25 MHz to <30 MHz	10 kHz
30 MHz to <1 000 MHz	100 kHz
>1 000 MHz	1 MHz

8.7 Cordless audio transmitter shutoff

This clause does not apply to Band II LPD.

8.7.1 Definition

The transmitter shall have a built in timer facility that automatically switches off the RF carrier after a period of no input audio signal.

8.7.2 Method of measurement

The output of the transmitter shall be connected to a power meter with an audio input signal applied. When the audio signal is removed a timer is started and the power level recorded. When the switch off occurs the time period and new power levels are noted.

8.7.3 Limits

The carrier output power shall be reduced by ≥ 30 dB, less than 5 minutes after the input audio signal is removed.

9 Receiver

This clause does not apply to Band II LPD.

9.1 Spurious emissions and cabinet radiation

9.1.1 Definitions

Spurious emissions from the receiver are radio frequency emissions at any frequency, generated by the equipment, antenna, aerial amplifier, down converters or filter.

Manufacturers shall provide a representative sample of the receiver system. The level of spurious emissions shall be measured by either:

- a) the power level from an external RF port; and
- b) their effective radiated power when radiated by the cabinet and structure of the equipment (cabinet radiation);
or
- c) their effective radiated power when radiated by the cabinet and the integral antenna, in the case of equipment fitted with such an antenna and no external RF port.

9.1.2 Method of measuring the power level in a specified load

This method applies only to equipment with an external RF port.

The external RF port of the receiver under test shall be connected to a measuring receiver (see clause 8.6.4). The receiver under test shall be switched on, and the measuring receiver shall be tuned over the frequency range in table 11.

Table 11: Frequency range

Fundamental frequency range	lower frequency	upper frequency
9 kHz to 100 MHz	9 kHz	1 GHz
100 MHz to 300 MHz	9 kHz	10 th harmonic
300 MHz to 600 MHz	30 MHz	3 GHz
600 MHz to 5,2 GHz	30 MHz	5 th harmonic

The test should include the entire harmonic band and not be truncated at the precise upper frequency limit stated.

At each frequency at which a spurious component is detected, the power level shall be recorded as the spurious level delivered into the specified load.

9.1.3 Method of measuring the effective radiated power of the enclosure

This method applies only to equipment with an external RF port.

On a test site, selected from annex A, the equipment shall be placed at the specified height on a non-conducting support and in the position closest to normal use as declared by the manufacturer. The receiver antenna connector shall be connected to an artificial antenna.

The test antenna shall be oriented for vertical polarization and the length of the test antenna shall be chosen to correspond to the instantaneous frequency of the measuring receiver (see clause 8.6.4). The output of the test antenna shall be connected to a measuring receiver. The receiver shall be switched on and the measuring receiver shall be tuned over the frequency range as specified in clause 9.1.2. At each frequency at which a spurious component is detected, the test antenna shall be raised and lowered through the specified range of height until a maximum signal level is detected by the measuring receiver. When a test site according to clause A.3 is used there is no need to vary the height of the antenna. The receiver shall then be rotated through 360° in the horizontal plane until the maximum signal level is detected by the measuring receiver. The maximum signal level detected by the measuring receiver shall be noted.

The receiver shall be replaced by a substitution antenna as defined in clause A.1.3.

The substitution antenna shall be oriented for vertical polarization and the length of the substitution antenna shall be adjusted to correspond to the frequency of the spurious component detected.

The substitution antenna shall be connected to a calibrated signal generator.

The frequency of the calibrated signal generator shall be set to the frequency of the spurious component detected.

The input attenuator setting of the measuring receiver shall be adjusted in order to increase the sensitivity of the measuring receiver, if necessary.

The test antenna shall be raised and lowered through the specified range of height to ensure that the maximum signal is received. The input signal to the substitution antenna shall be adjusted to the level that produces a level detected by the measuring receiver, that is equal to the level noted while the spurious component was measured, corrected for the change of input attenuator setting of the measuring receiver. The input level to the substitution antenna shall be recorded as power level, corrected for the change of input attenuator setting of the measuring receiver.

The measurement shall be repeated with the test antenna and the substitution antenna oriented for horizontal polarization.

The measure of the effective radiated power of the spurious components is the larger of the two power levels recorded for each spurious component at the input to the substitution antenna, corrected for the gain of the antenna if necessary.

9.1.4 Method of measuring the effective radiated power

This method applies only to equipment with an integral antenna.

The method of measurement shall be performed according to clause 9.1.3, except that the receiver input shall be connected to the integral antenna and not to an artificial antenna.

9.1.5 Limits

The power of the spurious emissions shall not exceed the limits of table 12.

Table 12: Limits for receiver spurious emissions

Measurement	25 MHz to 1 000 MHz	Frequencies above 1 000 MHz
erp	2 nW	20 nW

10 Measurement uncertainty

10.1 Compliance assessment when measurement uncertainty is equal to or less than maximum acceptable uncertainty

The interpretation of the results when comparing measurement values with specification limits shall be as follows:

- a) When the measured value does not exceed the limit value, the equipment under test meets the requirements of the standard.

- b) When the measured value exceeds the limit value, the equipment under test does not meet the requirements of the standard.
- c) The measurement uncertainty calculated by the test technician carrying out the measurement shall be recorded in the test report.
- d) The measurement uncertainty calculated by the test technician may be a maximum value for a range of values of measurement, or may be the measurement uncertainty for the specific measurement undertaken. The method used shall be recorded in the test report.

10.2 Compliance assessment when measurement uncertainty is greater than maximum acceptable uncertainty

The interpretation of the results when comparing measurement values with specification limits shall be as follows:

- a) When the measured value plus the difference between the maximum allowable measurement uncertainty and the measurement uncertainty calculated by the test technician does not exceed the limit value, the equipment under test meets the requirements of the standard.
- b) When the measured value plus the difference between the maximum allowable measurement uncertainty and the measurement uncertainty calculated by the test technician exceeds the limit value, the equipment under test does not meet the requirements of the standard.
- c) The measurement uncertainty calculated by the test technician carrying out the measurement shall be recorded in the test report.
- d) The measurement uncertainty calculated by the test technician may be a maximum value for a range of values of measurement, or may be the measurement uncertainty for the specific measurement undertaken. The method used shall be recorded in the test report.

10.3 Maximum allowable measurement uncertainties

Table 9 gives the maximum allowable measurement uncertainties applicable to measured parameters unless otherwise stated in the present document.

Table 13: Maximum allowable measurement uncertainty

Parameter	Uncertainty
RF frequency	$< \pm 1 \times 10^{-7}$
Audio Output power	$< \pm 0,5$ dB
Radiated RF power	$< \pm 6$ dB
Conducted RF power variations using a test fixture	$< \pm 0,75$ dB
Maximum frequency deviation:	
- within 300 Hz and 6 kHz of audio frequency	$< \pm 5$ %
- within 6 kHz and 25 kHz of audio frequency	$< \pm 3$ dB
Deviation limitation	$< \pm 5$ %
Radiated emission of transmitter, valid up to 12,75 GHz	$< \pm 6$ dB
Radiated emission of receiver, valid up to 12,75 GHz	$< \pm 6$ dB
Transmitter switch off time	$< \pm 5$ %

Annex A (normative): Radiated measurement

This annex has been drafted so that it could be used as well for the assessment of speech, data or equipment providing a specific response.

It covers test sites and methods to be used with integral antenna equipment or equipment having an antenna connector.

A.1 Test sites and general arrangements for measurements involving the use of radiated fields

This clause introduces three most commonly available test sites, an anechoic chamber, an anechoic chamber with a ground plane and an Open Area Test Site (OATS), which may be used for radiated tests. These test sites are generally referred to as free field test sites. Both absolute and relative measurements can be performed in these sites. Where absolute measurements are to be carried out, the chamber should be verified. A detailed verification procedure is described in TR 102 273 [7] relevant parts 2, 3 and 4.

NOTE: To ensure reproducibility and tractability of radiated measurements only these test sites should be used in measurements in accordance with the present document.

A.1.1 Anechoic chamber

An anechoic chamber is an enclosure, usually shielded, whose internal walls, floor and ceiling are covered with radio absorbing material, normally of the pyramidal urethane foam type. The chamber usually contains an antenna support at one end and a turntable at the other. A typical anechoic chamber is shown in figure A.1.

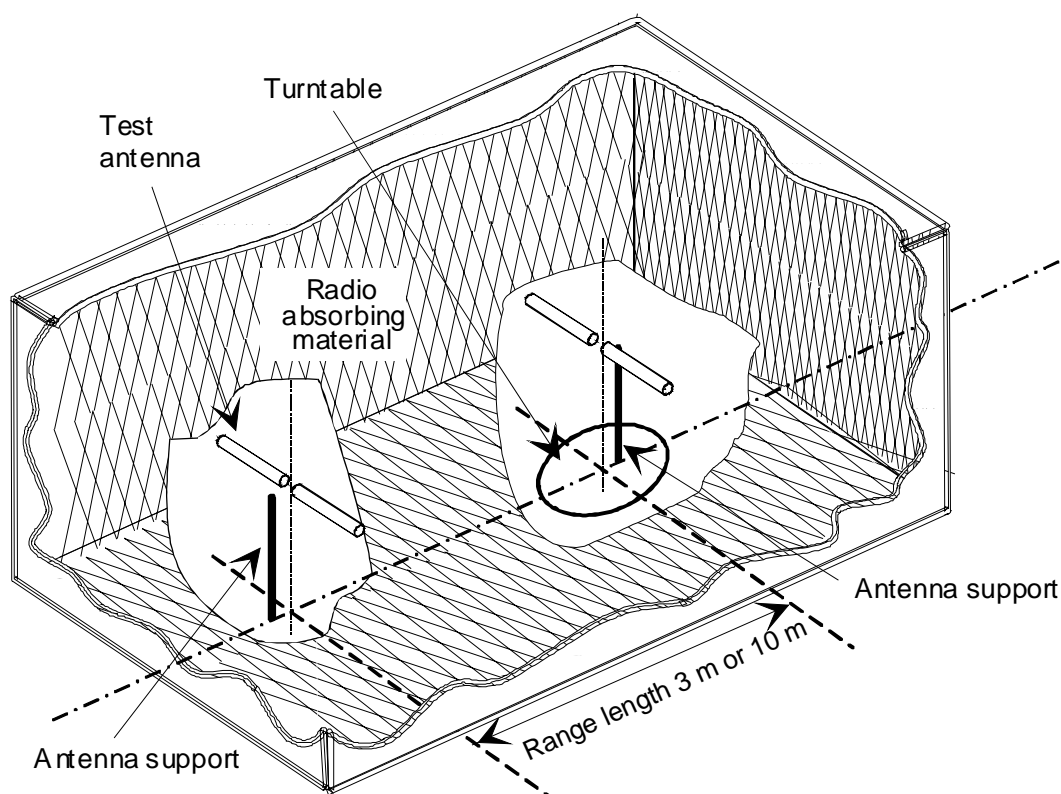

Figure A.1: A typical fully lined anechoic chamber

The chamber shielding and radio absorbing material work together to provide a controlled environment for testing purposes. This type of test chamber attempts to simulate free space conditions.

The shielding provides a test space, with reduced levels of interference from ambient signals and other outside effects, whilst the radio absorbing material minimizes unwanted reflections from the walls and ceiling which can influence the measurements. In practice it is relatively easy for shielding to provide high levels (80 dB to 140 dB) of ambient interference rejection, normally making ambient interference negligible.

A turntable is capable of rotation through 360° in the horizontal plane and it is used to support the test sample (EUT) at a suitable height (e.g. 1 m) above the ground plane. The chamber shall be large enough to allow the measuring distance of at least 3 m or $2(d_1+d_2)^2/\lambda$ (m), whichever is greater (see clause A.2.5). The distance used in actual measurements shall be recorded with the test results.

The anechoic chamber generally has several advantages over other test facilities. There is minimal ambient interference, minimal floor, ceiling and wall reflections and it is independent of the weather. It does however have some disadvantages which include limited measuring distance and limited lower frequency usage due to the size of the pyramidal absorbers. To improve low frequency performance, a combination structure of ferrite tiles and urethane foam absorbers is commonly used.

All types of emission, sensitivity and immunity testing can be carried out within an anechoic chamber without limitation.

A.1.2 Anechoic chamber with a conductive ground plane

An anechoic chamber with a conductive ground plane is an enclosure, usually shielded, whose internal walls and ceiling are covered with radio absorbing material, normally of the pyramidal urethane foam type. The floor, which is metallic, is not covered and forms the ground plane. The chamber usually contains an antenna mast at one end and a turntable at the other. A typical anechoic chamber with a conductive ground plane is shown in figure A.2.

This type of test chamber attempts to simulate an ideal Open Area Test Site whose primary characteristic is a perfectly conducting ground plane of infinite extent.

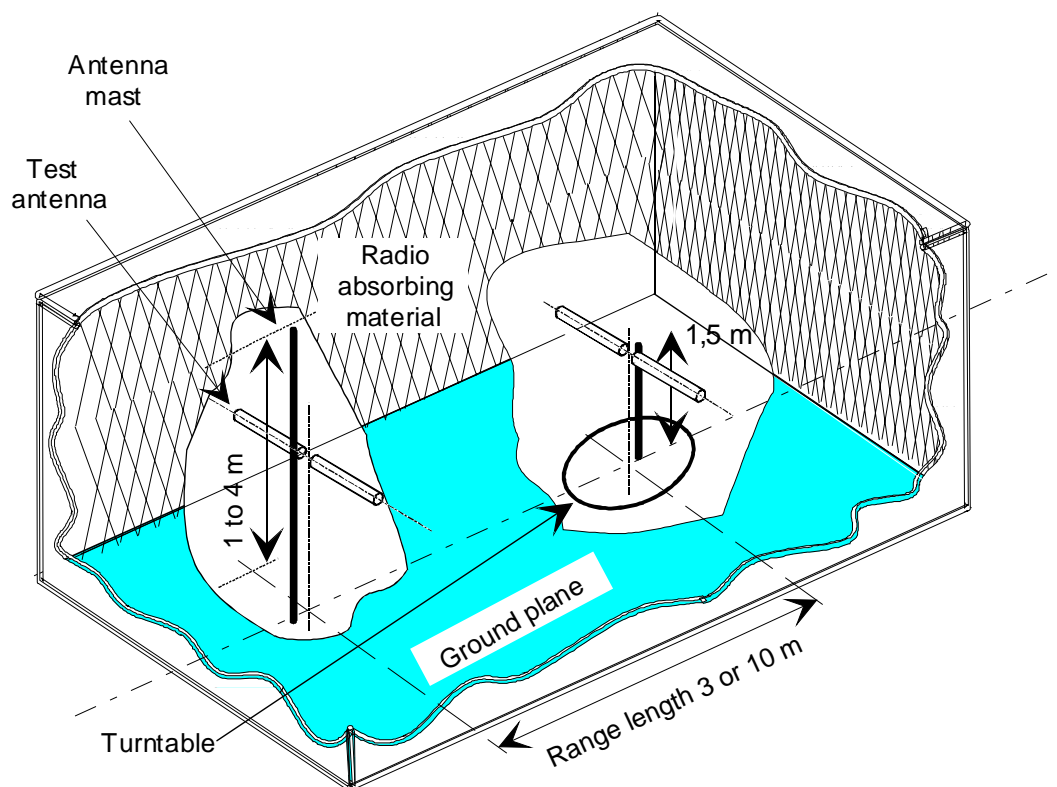

Figure A.2: A typical anechoic chamber with a conductive ground plane

In this facility the ground plane creates the wanted reflection path, such that the signal received by the receiving antenna is the sum of the signals from both the direct and reflected transmission paths. This creates a unique received signal level for each height of the transmitting antenna (or EUT) and the receiving antenna above the ground plane.

The antenna mast provides a variable height facility (from 1 m to 4 m) so that the position of the test antenna can be optimized for maximum coupled signal between antennas or between an EUT and the test antenna.

A turntable is capable of rotation through 360° in the horizontal plane and it is used to support the test sample (EUT) at a specified height, usually 1,5 m. above the ground plane. The chamber shall be large enough to allow the measuring distance of at least 3 m or $2(d_1+d_2)^2/\lambda$ (m), whichever is greater (see clause A.2.5). The distance used in actual measurements shall be recorded with the test results.

Emission testing involves firstly "peaking" the field strength from the EUT by raising and lowering the receiving antenna on the mast (to obtain the maximum constructive interference of the direct and reflected signals from the EUT) and then rotating the turntable for a "peak" in the azimuth plane. At this height of the test antenna on the mast, the amplitude of the received signal is noted. Secondly the EUT is replaced by a substitution antenna (positioned at the EUT's phase or volume centre) which is connected to a signal generator. The signal is again "peaked" and the signal generator output adjusted until the level, noted in stage one, is again measured on the receiving device.

Receiver sensitivity tests over a ground plane also involve "peaking" the field strength by raising and lowering the test antenna on the mast to obtain the maximum constructive interference of the direct and reflected signals, this time using a measuring antenna which has been positioned where the phase or volume centre of the EUT will be during testing. A transform factor is derived. The test antenna remains at the same height for stage two, during which the measuring antenna is replaced by the EUT. The amplitude of the transmitted signal is reduced to determine the field strength level at which a specified response is obtained from the EUT.

A.1.3 Open Area Test Site (OATS)

An Open Area Test Site comprises a turntable at one end and an antenna mast of variable height at the other end above a ground plane which, in the ideal case, is perfectly conducting and of infinite extent. In practice, whilst good conductivity can be achieved, the ground plane size has to be limited. A typical Open Area Test Site is shown in figure A.3.

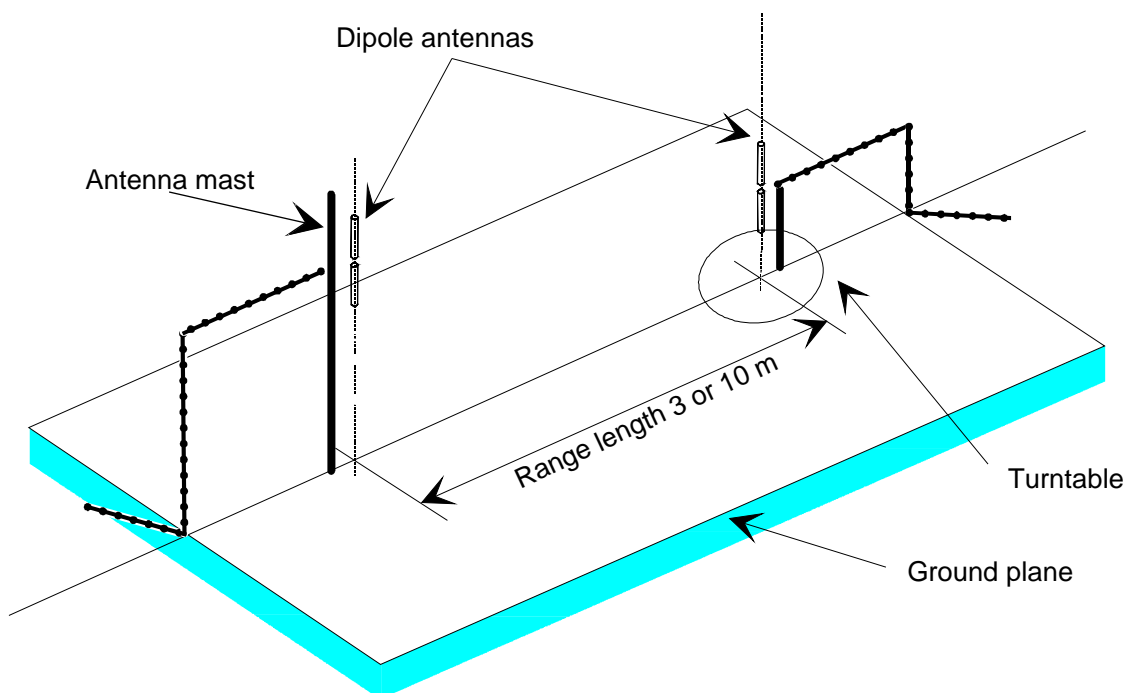

Figure A.3: A typical Open Area Test Site

The ground plane creates a wanted reflection path, such that the signal received by the receiving antenna is the sum of the signals received from the direct and reflected transmission paths. The phasing of these two signals creates a unique received level for each height of the transmitting antenna (or EUT) and the receiving antenna above the ground plane.

Site qualification concerning antenna positions, turntable, measurement distance and other arrangements are same as for anechoic chamber with a ground plane. In radiated measurements an OATS is also used by the same way as anechoic chamber with a ground plane.

Typical measuring arrangement common for ground plane test sites is presented in the figure A.4.

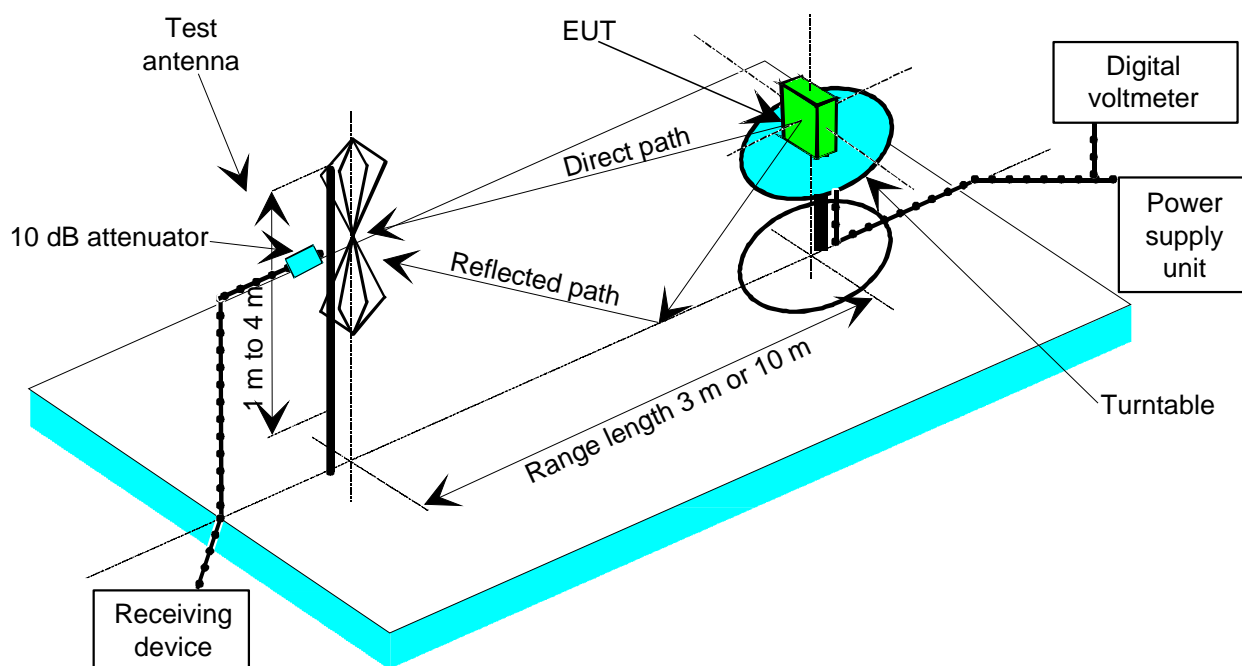

Figure A.4: Measuring arrangement on ground plane test site (OATS set-up for spurious emission testing)

A.1.4 Test antenna

A test antenna is always used in radiated test methods. In emission tests (i.e. frequency error, effective radiated power, spurious emissions and adjacent channel power) the test antenna is used to detect the field from the EUT in one stage of the measurement and from the substitution antenna in the other stage. When the test site is used for the measurement of receiver characteristics (i.e. sensitivity and various immunity parameters) the antenna is used as the transmitting device.

The test antenna should be mounted on a support capable of allowing the antenna to be used in either horizontal or vertical polarization which, on ground plane sites (i.e. anechoic chambers with ground planes and Open Area Test Sites), should additionally allow the height of its centre above the ground to be varied over the specified range (usually 1 metre to 4 metres).

In the frequency band 30 MHz to 1 000 MHz, dipole antennas (constructed in accordance with ANSI C63.5 [8]) are generally recommended. For frequencies of 80 MHz and above, the dipoles should have their arm lengths set for resonance at the frequency of test. Below 80 MHz, shortened arm lengths are recommended. For spurious emission testing, however, a combination of bicones and log periodic dipole array antennas (commonly termed "log periodics") could be used to cover the entire 30 MHz to 1 000 MHz band. Above 1 000 MHz, waveguide horns are recommended although, again, log periodics could be used.

NOTE: The gain of a horn antenna is generally expressed relative to an isotropic radiator.

A.1.5 Substitution antenna

The substitution antenna is used to replace the EUT for tests in which a transmitting parameter (i.e. frequency error, effective radiated power, spurious emissions and adjacent channel power) is being measured. For measurements in the frequency band 30 MHz to 1 000 MHz, the substitution antenna should be a dipole antenna (constructed in accordance with ANSI C63.5 [8]). For frequencies of 80 MHz and above, the dipoles should have their arm lengths set for resonance at the frequency of test. Below 80 MHz, shortened arm lengths are recommended. For measurements above 1 000 MHz, a waveguide horn is recommended. The centre of this antenna should coincide with either the phase centre or volume centre.

A.1.6 Measuring antenna

The measuring antenna is used in tests on an EUT in which a receiving parameter (i.e. sensitivity and various immunity tests) is being measured. Its purpose is to enable a measurement of the electric field strength in the vicinity of the EUT. For measurements in the frequency band 30 MHz to 1 000 MHz, the measuring antenna should be a dipole antenna (constructed in accordance with ANSI C63.5 [8]). For frequencies of 80 MHz and above, the dipoles should have their arm lengths set for resonance at the frequency of test. Below 80 MHz, shortened arm lengths are recommended. The centre of this antenna should coincide with either the phase centre or volume centre (as specified in the test method) of the EUT.

A.1.7 Stripline arrangement

A.1.7.1 General

The stripline arrangement is a RF coupling device for coupling the integral antenna of an equipment to a 50 Ω radio frequency terminal. This allows the radiated measurements to be performed without an open air test site but in a restricted frequency range. Absolute or relative measurements can be performed; absolute measurements require a calibration of the stripline arrangement.

A.1.7.2 Description

The stripline is made of three highly conductive sheets forming part of a transmission line which allows the equipment under test to be placed within a known electric field. They shall be sufficiently rigid to support the equipment under test.

Two examples of stripline characteristics are given below:

		IEC 489-3 App. J	FTZ N°512 TB 9
Useful frequency range	MHz	1 to 200	0,1 to 4 000
Equipment size limits	length	200 mm	1 200 mm
(antenna included):	width	200 mm	1 200 mm
	height	250 mm	400 mm

A.1.7.3 Calibration

The aim of calibration is to establish at any frequency a relationship between the voltage applied by the signal generator and the field strength at the designated test area inside the stripline.

A.1.7.4 Mode of use

The stripline arrangement may be used for all radiated measurements within its calibrated frequency range.

The method of measurement is the same as the method using an open air test site with the following change. The stripline arrangement input socket is used instead of the test antenna.

A.2 Guidance on the use of radiation test sites

This clause details procedures, test equipment arrangements and verification that should be carried out before any of the radiated test are undertaken. These schemes are common to all types of test sites described in annex A.

A.2.1 Verification of the test site

No test should be carried out on a test site which does not possess a valid certificate of verification. The verification procedures for the different types of test sites described in annex A (i.e. anechoic chamber, anechoic chamber with a ground plane and Open Area Test Site) are given in TR 102 273 [7], parts 2, 3 and 4, respectively.

A.2.2 Preparation of the EUT

The manufacturer should supply information about the EUT covering the operating frequency, polarization, supply voltage(s) and the reference face. Additional information, specific to the type of EUT should include, where relevant, carrier power, channel separation, whether different operating modes are available (e.g. high and low power modes) and if operation is continuous or is subject to a maximum test duty cycle (e.g. 1 minute on, 4 minutes off).

Where necessary, a mounting bracket of minimal size should be available for mounting the EUT on the turntable. This bracket should be made from low conductivity, low relative dielectric constant (i.e. less than 1,5) material(s) such as expanded polystyrene, balsa wood, etc.

A.2.3 Power supplies to the EUT

All tests should be performed using power supplies wherever possible, including tests on EUT designed for battery-only use. In all cases, power leads should be connected to the EUT's supply terminals (and monitored with a digital voltmeter) but the battery should remain present, electrically isolated from the rest of the equipment, possibly by putting tape over its contacts.

The presence of these power cables can, however, affect the measured performance of the EUT. For this reason, they should be made to be "transparent" as far as the testing is concerned. This can be achieved by routing them away from the EUT and down to the either the screen, ground plane or facility wall (as appropriate) by the shortest possible paths. Precautions should be taken to minimize pick-up on these leads (e.g. the leads could be twisted together, loaded with ferrite beads at 0,15 m spacing or otherwise loaded).

A.2.4 Volume control setting for analogue speech tests

Unless otherwise stated, in all receiver measurements for analogue speech the receiver volume control where possible, should be adjusted to give at least 50 % of the rated audio output power. In the case of stepped volume controls, to volume control should be set to the first step that provides an output power of at least 50 % of the rated audio output power. This control should not be readjusted between normal and extreme test conditions in tests.

A.2.5 Range length

The range length for all these types of test facility should be adequate to allow for testing in the far-field of the EUT i.e. it should be equal to or exceed:

$$\frac{2(d_1 + d_2)^2}{\lambda}$$

where:

d_1 is the largest dimension of the EUT/dipole after substitution (m);

d_2 is the largest dimension of the test antenna (m);

λ is the test frequency wavelength (m).

It should be noted that in the substitution part of this measurement, where both test and substitution antennas are half wavelength dipoles, this minimum range length for far-field testing would be:

$$2\lambda$$

It should be noted in the test report when either of these conditions is not met so that the additional measurement uncertainty can be incorporated into the results.

NOTE 1: **For the fully anechoic chamber**, no part of the volume of the EUT should, at any angle of rotation of the turntable, fall outside the "quiet zone" of the chamber at the nominal frequency of the test.

NOTE 2: The "quiet zone" is a volume within the anechoic chamber (without a ground plane) in which a specified performance has either been proven by test, or is guaranteed by the designer/manufacture. The specified performance is usually the reflectivity of the absorbing panels or a directly related parameter (e.g. signal uniformity in amplitude and phase). It should be noted however that the defining levels of the quiet zone tend to vary.

NOTE 3: **For the anechoic chamber with a ground plane**, a full height scanning capability, i.e. 1 m to 4 m, should be available for which no part of the test antenna should come within 1 m of the absorbing panels. For both types of Anechoic Chamber, the reflectivity of the absorbing panels should not be worse than -5 dB.

NOTE 4: **For both the anechoic chamber with a ground plane and the Open Area Test Site**, no part of any antenna should come within 0,25 m of the ground plane at any time throughout the tests. Where any of these conditions cannot be met, measurements should not be carried out.

A.2.6 Site preparation

The cables for both ends of the test site should be routed horizontally away from the testing area for a minimum of 2 m (unless, in the case both types of anechoic chamber, a back wall is reached) and then allowed to drop vertically and out through either the ground plane or screen (as appropriate) to the test equipment. Precautions should be taken to minimize pick up on these leads (e.g. dressing with ferrite beads, or other loading). The cables, their routing and dressing should be identical to the verification set-up.

NOTE: For ground reflection test sites (i.e. anechoic chambers with ground planes and Open Area Test Sites) which incorporate a cable drum with the antenna mast, the 2 m requirement may be impossible to comply with.

Calibration data for all items of test equipment should be available and valid. For test, substitution and measuring antennas, the data should include gain relative to an isotropic radiator (or antenna factor) for the frequency of test. Also, the VSWR of the substitution and measuring antennas should be known.

The calibration data on all cables and attenuators should include insertion loss and VSWR throughout the entire frequency range of the tests. All VSWR and insertion loss figures should be recorded in the log book results sheet for the specific test.

Where correction factors/tables are required, these should be immediately available.

For all items of test equipment, the maximum errors they exhibit should be known along with the distribution of the error e.g.:

- cable loss: $\pm 0,5$ dB with a rectangular distribution;
- measuring receiver: 1,0 dB (standard deviation) signal level accuracy with a Gaussian error distribution.

At the start of measurements, system checks should be made on the items of test equipment used on the test site.

A.3 Coupling of signals

A.3.1 General

The presence of leads in the radiated field may cause a disturbance of that field and lead to additional measurement uncertainty. These disturbances can be minimized by using suitable coupling methods, offering signal isolation and minimum field disturbance (e.g. optical and acoustic coupling).

A.3.2 Data Signals

Isolation can be provided by the use of optical, ultra sonic or infra red means. Field disturbance can be minimized by using a suitable fibre optic connection. Ultra sonic or infra red radiated connections require suitable measures for the minimization of ambient noise.

A.3.3 Speech and analogue signals

Where an audio output socket is not available an acoustic coupler should be used.

When using the acoustic coupler, care should be exercised that possible ambient noise does not influence the test result.

A.3.3.1 Acoustic coupler description

The acoustic coupler comprises a plastic funnel, an acoustic pipe and a microphone with a suitable amplifier. The materials used to fabricate the funnel and pipe should be of low conductivity and of low relative dielectric constant (i.e. less than 1,5).

- The acoustic pipe should be long enough to reach from the EUT to the microphone which should be located in a position that will not disturb the RF field. The acoustic pipe should have an inner diameter of about 6 mm and a wall thickness of about 1,5 mm and should be sufficiently flexible so as not to hinder the rotation of the turntable.
- The plastic funnel should have a diameter appropriate to the size of the loudspeaker in the EUT, with soft foam rubber glued to its edge, it should be fitted to one end of the acoustic pipe and the microphone should be fitted to the other end. It is very important to fix the centre of the funnel in a reproducible position relative to the EUT, since the position of the centre has a strong influence on the frequency response that will be measured. This can be achieved by placing the EUT in a close fitting acoustic mounting jig, supplied by the manufacturer, of which the funnel is an integral part.
- The microphone should have a response characteristic flat within 1 dB over a frequency range of 50 Hz to 20 kHz, a linear dynamic range of at least 50 dB. The sensitivity of the microphone and the receiver audio output level should be suitable to measure a signal to noise ratio of at least 40 dB at the nominal audio output level of the EUT. Its size should be sufficiently small to couple to the acoustic pipe.
- The frequency correcting network should correct the frequency response of the acoustic coupler so that the acoustic SINAD measurement is valid (see IEC 60489-3 [9], appendix F [A.6]).

A.3.3.2 Calibration

The aim of the calibration of the acoustic coupler is to determine the acoustic SINAD ratio which is equivalent to the SINAD ratio at the receiver output.

A.4 Standard test position

The standard position in all test sites, except the stripline arrangement, for equipment which is not intended to be worn on a person, including hand-held equipment, shall be on a non conducting support, height 1,5 m, capable of rotating about a vertical axis through the equipment. The standard position of the equipment shall be the following:

- a) for equipment with an internal antenna, it shall be placed in the position closest to normal use as declared by the manufacturer;
- b) for equipment with a rigid external antenna, the antenna shall be vertical;
- c) for equipment with a non-rigid external antenna, the antenna shall be extended vertically upwards by a non-conducting support.

Equipment which is intended to be worn on a person may be tested using a simulated man as support.

The simulated man comprises a rotatable acrylic tube filled with salt water, placed on the ground.

The container shall have the following dimensions:

- Height: 1,7 m \pm 0,1 m;
- Inside diameter: 300 mm \pm 5 mm;
- Sidewall thickness: 5 mm \pm 0,5 mm.

The container shall be filled with a salt (NaCl) solution of 1,5 g per litre of distilled water.

The equipment shall be fixed to the surface of the simulated man, at the appropriate height for the equipment.

NOTE: To reduce the weight of the simulated man it may be possible to use an alternative tube which has a hollow centre of 220 mm maximum diameter.

In the stripline arrangement the equipment under test or the substitution antenna is placed in the designated test area in the normal operational position, relative to the applied field, on a pedestal made of a low dielectric material (dielectric constant less than 2).

A.5 Test fixture

The test fixture is only needed for the assessment of integral antenna equipment.

A.5.1 Description

The test fixture is a radio frequency coupling device associated with an integral antenna equipment for coupling the integral antenna to a 50 Ω radio frequency terminal at the working frequencies of the equipment under test. This allows certain measurements to be performed using the conducted measurement methods. Only relative measurements may be performed and only those at or near frequencies for which the test fixture has been calibrated.

In addition, the test fixture may provide:

- a) a connection to an external power supply;
- b) in the case of assessment of speech equipment, an audio interface either by direct connection or by an acoustic coupler.

In the case of non-speech equipment, the test fixture can also provide the suitable coupling means e.g. for the data output.

The test fixture shall normally be provided by the manufacturer.

The performance characteristics of the test fixture shall be approved by the testing laboratory and shall conform to the following basic parameters:

- a) the coupling loss shall not be greater than 30 dB;
- b) a coupling loss variation over the frequency range used in the measurement which does not exceed 2 dB;
- c) circuitry associated with the RF coupling shall contain no active or non-linear devices;
- d) the VSWR at the 50 Ω socket shall not be more than 1,5 over the frequency range of the measurements;
- e) the coupling loss shall be independent of the position of the test fixture and be unaffected by the proximity of surrounding objects or people. The coupling loss shall be reproducible when the equipment under test is removed and replaced;
- f) the coupling loss shall remain substantially constant when the environmental conditions are varied.

The characteristics and calibration shall be included in the test report.

A.5.2 Calibration

The calibration of the test fixture establishes a relationship between the output of the signal generator and the field strength applied to the equipment placed in the test fixture.

The calibration is valid only at a given frequency and for a given polarization of the reference field.

The actual set-up used depends on the type of the equipment (e.g. data, speech etc.)

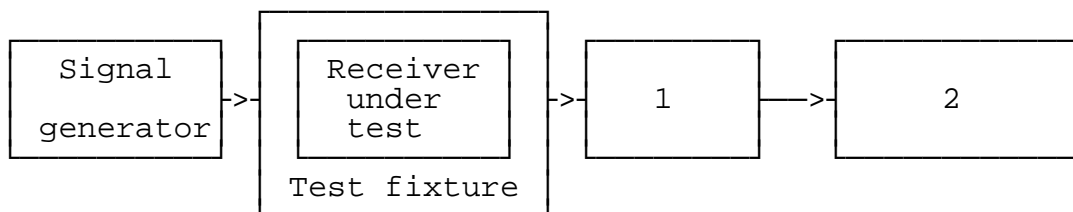

- 1) Coupling device, e.g. AF load/acoustic coupler (in the case of speech equipment).
- 2) Device for assessing the performance, e.g. distortion factor/audio level meter, BER measuring device etc.

Figure A.5: Measuring arrangement for calibration

Method of calibration:

- a) Measure the sensitivity expressed as a field strength, as specified in the present document and note the value of this field strength in dB μ V/m and the polarization used.
- b) Place the receiver in the test fixture which is connected to the signal generator. The level of the signal generator producing:
 - a SINAD of 20 dB;
 - a bit error ratio of 0,01; or
 - a message acceptance ratio of 80 %, as appropriate;
 shall be noted.

The calibration of the test fixture is the relationship between the field strength in dB μ V/m and the signal generator level in dB μ V emf. This relationship is expected to be linear.

A.5.3 Mode of use

The test fixture may be used to facilitate some of the measurements in the case of equipment having an integral antenna.

It is used in particular for the measurement of the radiated carrier power and usable sensitivity expressed as a field strength under the extreme conditions.

For the transmitter measurements calibration is not required as relative measuring methods are used.

For the receiver measurements calibration is necessary as absolute measurements are used.

To apply the specified wanted signal level expressed in field strength, convert it into the signal generator level (emf) using the calibration of the test fixture. Apply this value to the signal generator.

Annex B (normative): Measurement of Necessary Bandwidth (BN)

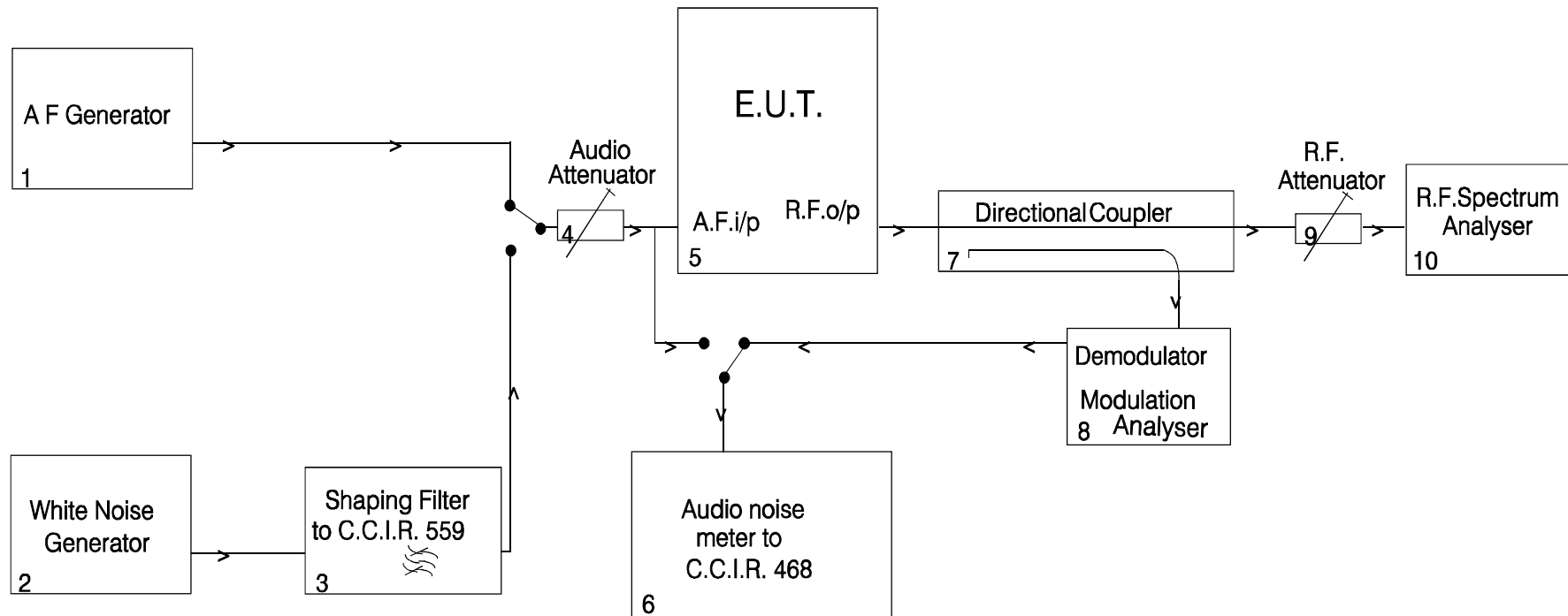

NOTE 1: If the EUT incorporates ancillary coding or signalling channels, for example, pilot tone, etc. these should be switched on prior to measuring the transmitter RF output spectrum.

NOTE 2: In the case of digital systems it is necessary to add test fixtures for the conversion of the audio input/output signals.

Figure B.1

Annex C (informative): Receiver parameters

The following information serves the purpose to give guidance to manufacturers on the design for the receiver part. The aim is to have as much as possible efficient use of the wireless application with the highest spectral efficiency.

C.1 Blocking or desensitization

C.1.1 Definition

Blocking immunity is a measure of the capability of the receiver to receive a wanted modulated signal without exceeding a given degradation due to the presence of an unwanted unmodulated input signal at any frequency within a defined distance. The spurious response frequencies are excluded.

It is specified as the ratio in decibels of the level of the unwanted signal to a specified level of the wanted signal at the receiver input for which a defined degradation of the received signal occurs.

C.1.2 Method of measurement

The method of measurement is derived from TR 100 027 [5] with some minor adaptations.

C.1.2.1 Measurement procedure

- a) The wanted signal and the unwanted signal should be connected to the receiver input via a combining network. The wanted signal can be either generated by the transmitter, which belongs to the receiver under test, but with a power regulator or damping network at the RF output or it can be represented by a signal generator capable to produce an appropriate modulated signal. The wanted signal has *nominal test modulation*. The unwanted signal is an unmodulated RF sine wave represented by a generator.
- b) Initially the unwanted signal should be switched off and the level of the wanted signal has to be adjusted to the *blocking reference signal level* measured at the receiver input.
- c) The frequency of the unwanted signal is set according the tables below (clause C.1.2.3 or C.1.2.4). Frequencies of spurious responses are excluded. The level of the unwanted signal has to be increased until the *defined signal degradation* at the receiver's output is observed. This level should be recorded for calculation of the blocking ratio.

C.1.2.2 Definitions

nominal test modulation: for equipment with analogue audio inputs on the transmitter side the nominal test modulation is a 1 kHz sine wave with nominal input level.

For equipment with digital inputs only at the transmitter side the manufacturer shall specify the input signal. In all cases the modulated spectrum shall be within the spectrum mask according the declared bandwidth.

blocking reference signal level: level of the wanted signal at which the blocking measurement takes place. The blocking reference signal level shall either be defined by the manufacturer or be defined as 3 dB higher than the *reference sensitivity level*. The manufacturer shall declare either the blocking reference signal level or the *reference sensitivity level*.

reference sensitivity level: RF level at the input of the receiver (using nominal test modulation without any unwanted signal) at which the *defined signal degradation* at the receiver output can be observed.

defined signal degradation: in analogue modulated systems the defined signal degradation is either 14 dB SINAD ratio at the receiver output or a reduction of 3 dB audio output power, whichever occurs first. In digital modulated systems the manufacturer shall define or describe the limit of signal degradation.

C.1.2.3 Limits for applications below 1 GHz

The limit values for the applications below 1 GHz should be higher or equal to the values given in table C.1.

Table C.1: Blocking limits at frequencies below 1 GHz

Class	Blocking (dB)		
	$\pm(1 \text{ MHz} + 2 \text{ B})$	$\pm 5 \text{ MHz}$	$\pm 10 \text{ MHz}$
1	50	60	70
2	30	40	50

C.1.2.4 Limits for applications above 1 GHz

The limit values for the applications above 1 GHz should be higher or equal to the values given in table C.2.

Table C.2: Blocking limits at frequencies above 1 GHz

Class	Blocking (dB)		
	$\pm(1 \text{ MHz} + 2 \text{ B})$	$\pm 5 \text{ MHz}$	$\pm 10 \text{ MHz}$
1	50	60	70

C.2 Frequency mask for the receiver part

C.2.1 Definition

The frequency mask for the receiver is giving information on the bandwidth and selectivity behaviour of the receiver. Depending on the application, analogue/digital with $B = 300 \text{ kHz}$ or wideband digital with $B = 600 \text{ kHz}$ or $1\,200 \text{ kHz}$, the receiver mask can be different.

C.2.2 Method of measurement

The measuring method is similar to TR 100 027 [5], adjacent channel selectivity measurement (see clause 8.1.3). Some minor modifications are in place as described below:

- Analogue modulation:
 - use test modulation A-M1 and A-M3 as described in TR 100 027 [5], clauses 3.1 and 8.1.3.1;
 - for the wanted signal definition, the wanted signal level is defined as the reference sensitivity level +3 dB.
- Digital modulation:
 - use test modulation as described in TR 100 027 [5], clauses 3.1 and 8.1.3.2;
 - the wanted signal level is described as the reference sensitivity +3 dB;
 - digital systems can however deviate from this method. In this case the applicant shall state the criteria used.

C.2.3 Typical values for receivers

Figure C.1 gives a graphical indication of the adjacent channel selectivity and i.e. displays the frequency mask. The curve is based upon discrete filters. Modern receiver architectures allow for more possibilities to achieve the required selectivity.

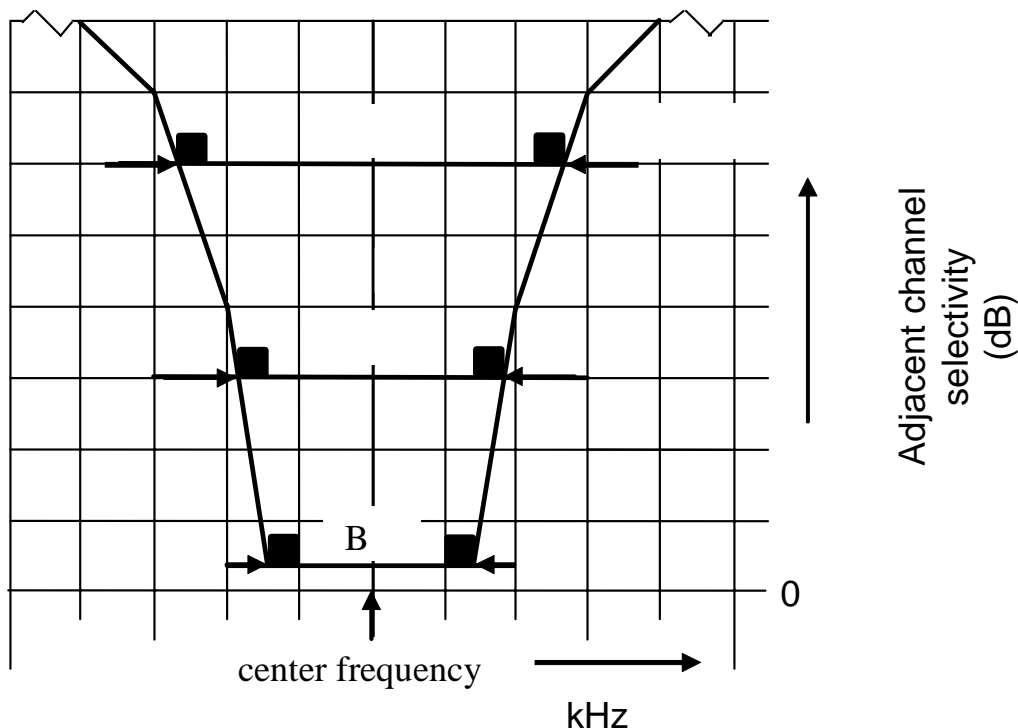

Figure C.1: Receiver frequency mask

C.2.3.1 Typical values for receivers with analogue modulation

The values are applicable for receivers that will match transmitters with defined bandwidth $B = 300$ kHz.

Table C.3: Adjacent channel selectivity

Class	Adjacent channel selectivity (dB)	
	2B (600 kHz)	4B (1 200 kHz)
1	45	60
2	15	30

C.2.3.2 Typical values for receivers with digital modulation

Due to limited experience with products the values are under consideration.

Annex D (informative): Derivation of radiated spurious emissions limit for Band II LPD

The 3 nW ERP limit for radiated spurious emissions for Band II LPD is close to the 4 nW erp spurious emissions limit within broadcasting bands for audio cordless devices (see table 9) and for short range devices (EN 300 220 [6]; table 13) in the operating mode.

The limit for radiated spurious emissions for Band II LPD has been derived as follows:

The radiated E-field limit is given in the EMC standard EN 301 489-1, table 4 [10] as:

- 30 dBuV/m at 10m for the frequency range 30 MHz to 230 MHz;
- 37 dBuV/m at 10m for the frequency range 230 MHz to 1000 MHz.

The radiated spurious emissions limit set to 3 nW (-55,2 dBm) presumes the following assumptions:

- Homogenous far field conditions (intrinsic impedance of free space $E/H = 120 \cdot \pi$);
- 30dBuV/m at 10m limit for the frequency range 30 to 1000 MHz.

NOTE: Derivation from E-Field limit to erp limit by assuming free space far field propagation conditions:

Electrical field limit E10 [dBuV/m at 10m]	E10= 30	d:= 10
Electrical field limit E [V/m]	$E = 10^{\left(\frac{E10}{20}\right)} \cdot 10^{-6}$	
Power density of isotropic antenna	$S := \frac{E^2}{2 \cdot 120 \pi}$	and $S := \frac{P}{4 \cdot \pi \cdot d^2}$
Equivalent isotropically radiated power EIRP [dBm]	$EIRP = 10 \cdot \log\left(\frac{S \cdot 4 \cdot \pi \cdot d^2}{10^{-3}}\right)$	EIRP= 57.8
Power gain of dipole antenna [dBi]	Gd= 2.15	
Effective radiated power ERP [dBm]	ERP= EIRP+ Gd	ERP= 55.6
Effective radiated power ERP [W]	$ERP = 10^{\left(\frac{ERP}{10}\right)} \cdot 10^{-3}$	ERP= 2.710 ⁻⁹

Annex E (informative): Justifications for field strength measurement

The methods of measurement within the standard for Band II LPD are a direct result of the work carried out in CEPT SE24 and especially the work of the SE24 sub group which carried out the practical tests.

- 1) The equipment is very low power in comparison with other low power devices.
- 2) The requirements for measurement means that to get an acceptable measurement the equipment cannot be separated by much more than 3 metres from the test antenna.
- 3) This distance of three meters is on the farfield/nearfield boundary (due to the size of the antennas at 100 MHz) when doing substitution measurements and hence the measurement uncertainty is unstable.
- 4) The spurious emission requirements have been reduced to the relevant EMC limits given in EN 301 489-1 [10], table 4. The spurious emission limits defined by ETSI for other telecommunication equipment falling under R&TTE directive are considerably higher than the 50nW transmit power limit for Band II LPD.

This approach was fully discussed in SE24 AdHoc and in SE24 and was the method of test used by the French test lab for the SE24 compatibility studies and is reflected in ECC Report 73.

Annex F (informative): Bibliography

CEPT/ERC/REC 01-06: "Procedure for mutual recognition of type testing and type approval for radio equipment".

ETSI ETR 028: "Radio Equipment and Systems (RES); Uncertainties in the measurement of mobile radio equipment characteristics".

CEPT/ERC/REC 70-03 relating to the use of Short Range Devices, annex 13.

ETSI EN 301 908-1: "Electromagnetic compatibility and Radio spectrum Matters (ERM); Base Stations (BS), Repeaters and User Equipment (UE) for IMT-2000 Third-Generation cellular networks; Part 1: Harmonized EN for IMT-2000, introduction and common requirements, covering essential requirements of article 3.2 of the R&TTE Directive".

ETSI EN 301 511: "Global System for Mobile communications (GSM); Harmonized EN for mobile stations in the GSM 900 and GSM 1800 bands covering essential requirements under article 3.2 of the R&TTE directive (1999/5/EC)".

History

Document history		
V1.1.1	July 1999	Publication as EN 301 357
V1.1.2	August 2000	Publication
V1.2.1	June 2001	Publication
V1.3.1	August 2005	Public Enquiry PE 20051230: 2005-08-31 to 2005-12-30
V1.3.1	May 2006	Vote V 20060721: 2006-05-22 to 2006-07-21
V1.3.1	July 2006	Publication